

1543
5x7/16

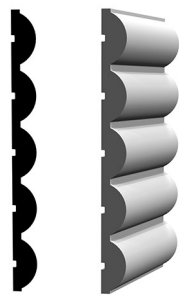

1544
5x7/16

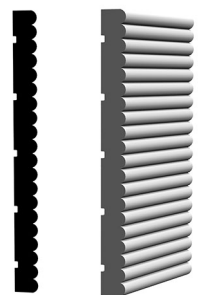

1545
5x7/16



OML13G
3-1/2x1-1/16



1520
1-1/16x1-3/8

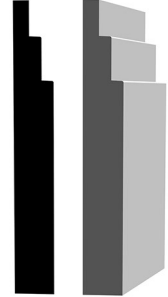

1262
5-1/2x3/4

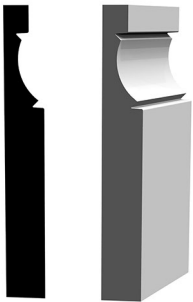

1267
5-1/2x3/4

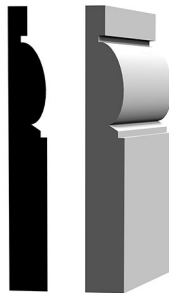

1272
5-1/2x3/4

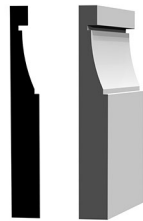

1277
5-1/2x3/4

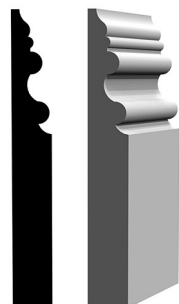

1282
5-1/2x3/4

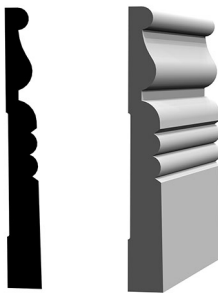

OML21
4x1/2

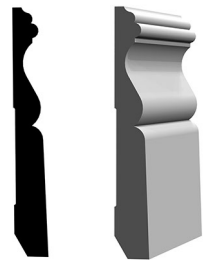

OML24
4-1/4x11/16

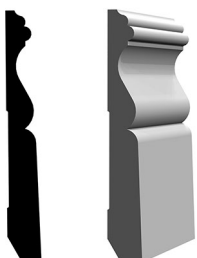

OML24A
4-1/4x1/2



OML24C
4-1/4x1/2

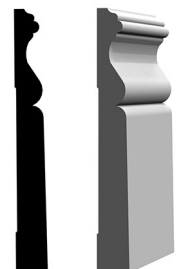

OML25
5-1/2x11/16

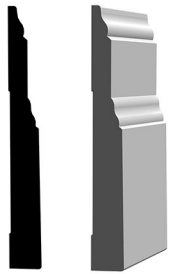

OML26
5-1/2x9/16

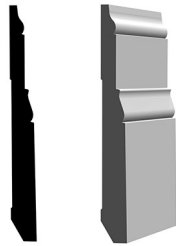

OML26A
4-1/2x1/2

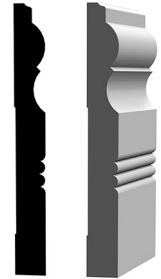

OML30
6-1/2x3/4

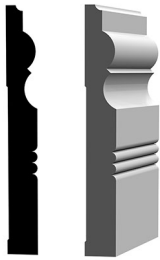

OML30A
5-1/2x11/16



OML30B
5-1/2x15/32



1530
1-1/4x11/16



OML126
1/2x3/4

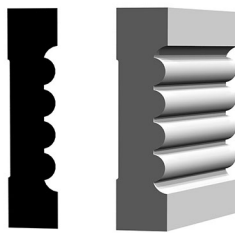

750
3-1/4x3/4

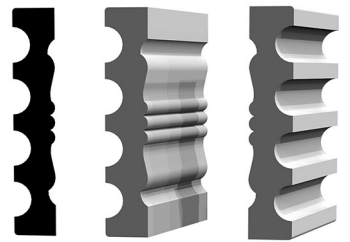

807
4x11/16

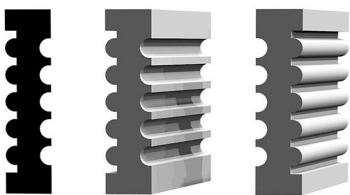

819
3x3/4

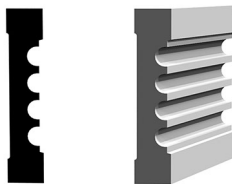

820
2-1/4x15/32

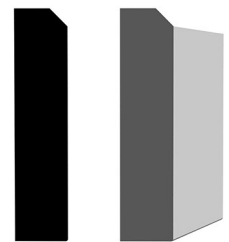

1208
3-1/4x3/4

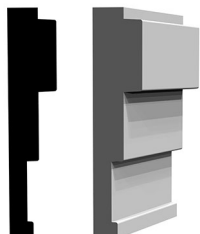

1263
3-1/2x3/4



1268
3-1/2x3/4



1273
3-1/2x3/4



1278
3-1/2x3/4

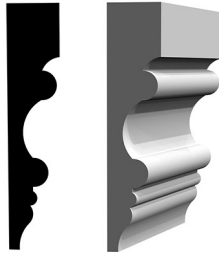

1283
3-1/2x3/4

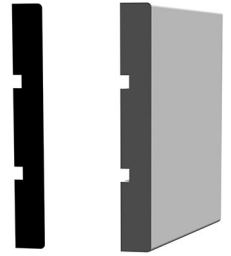

1536
3-1/2x7/16

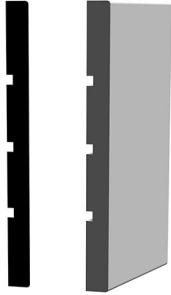

1537
5-1/2x7/16

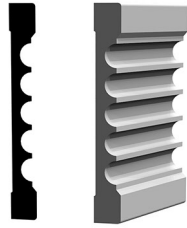

1644
4x1/2

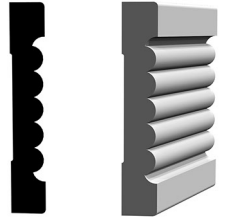

1753
5x1/2

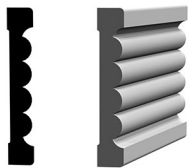

1821
2-1/4x3/8

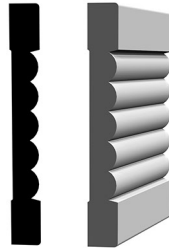

1824
4x1/2

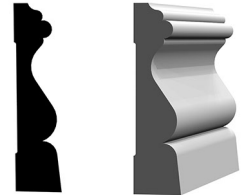

OML14
2-3/4x5/8

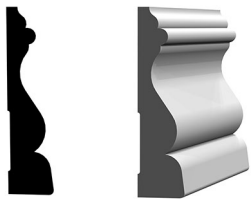

OML14A
2-1/2x5/8

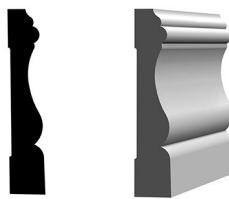

OML14B
2-3/4x1/2

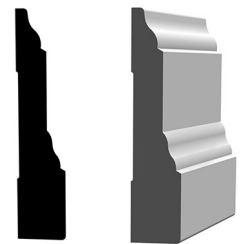

OML16
3-1/2x3/4

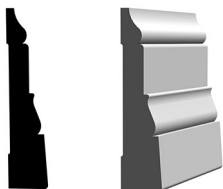

OML16A
2-3/4x5/8

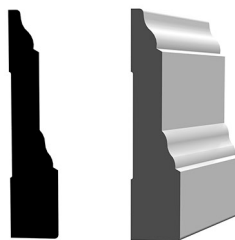

OML16G
3-1/4x21/32

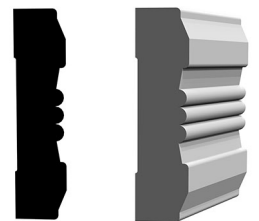

OML18
3-1/32x11/16

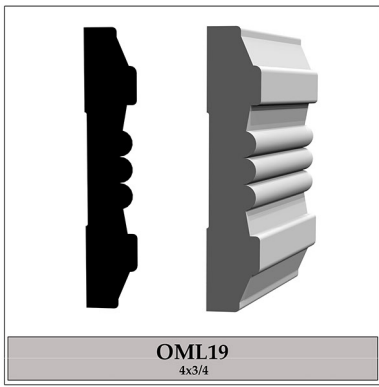

OML19
4x3/4

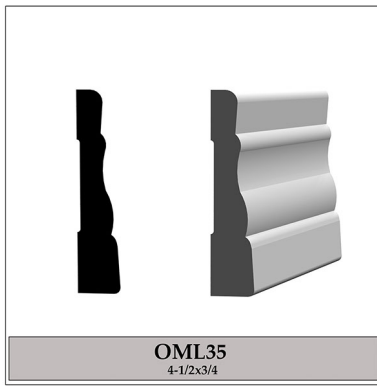

OML35
4-1/2x3/4

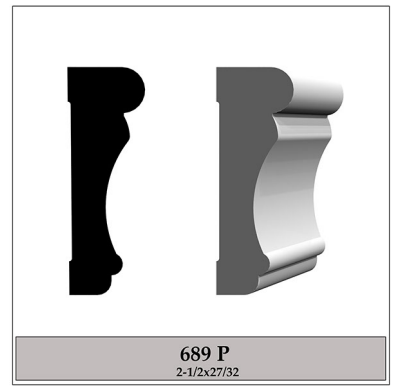

689 P
2-1/2x27/32

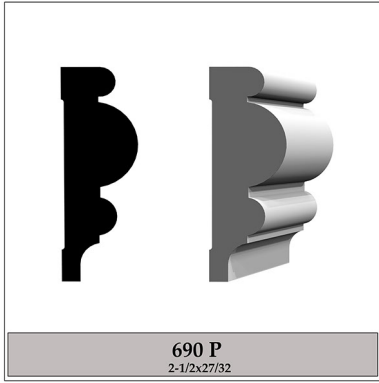

690 P
2-1/2x27/32

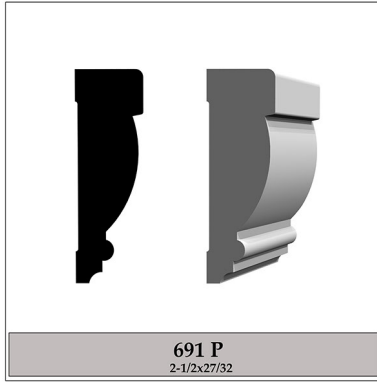

691 P
2-1/2x27/32

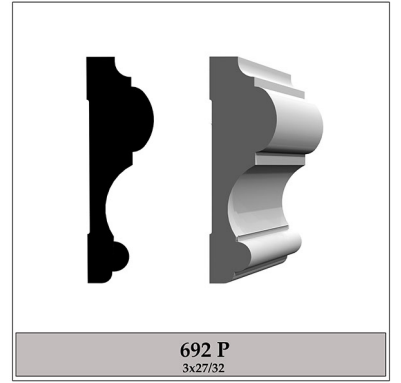

692 P
3x27/32

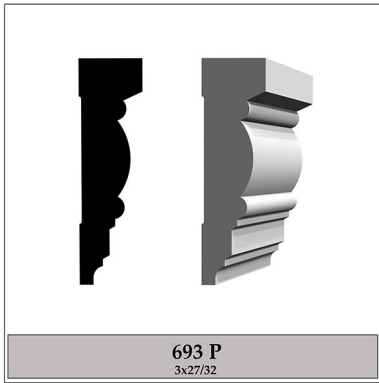

693 P
3x27/32

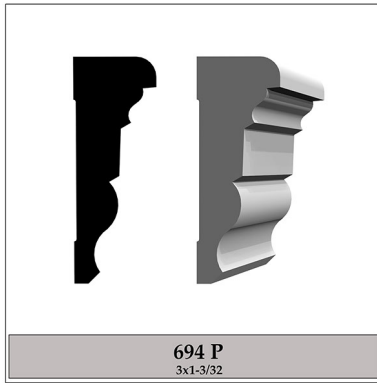

694 P
3x1-3/32

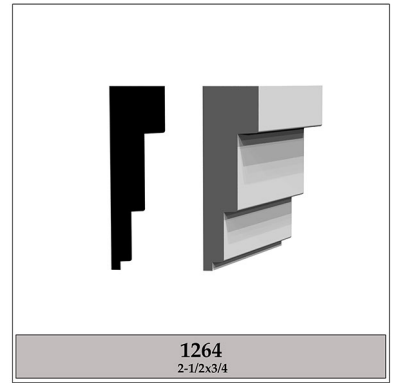

1264
2-1/2x3/4

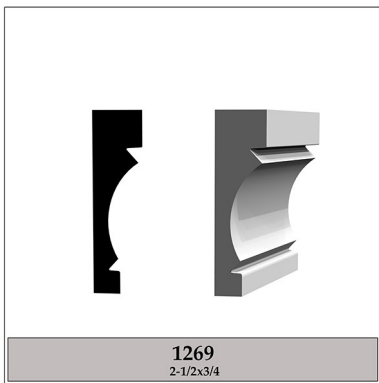

1269
2-1/2x3/4

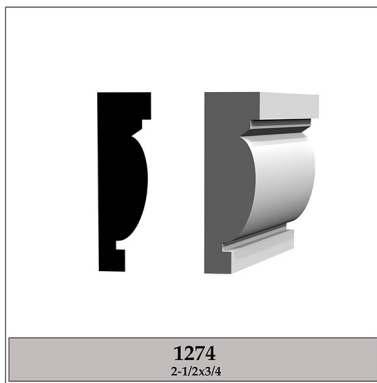

1274
2-1/2x3/4

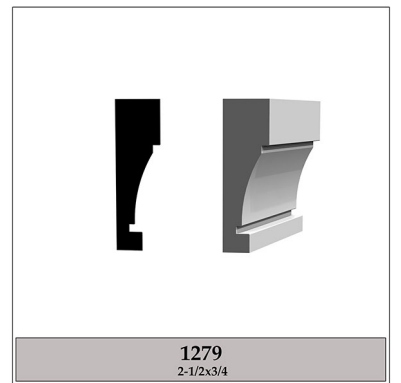

1279
2-1/2x3/4

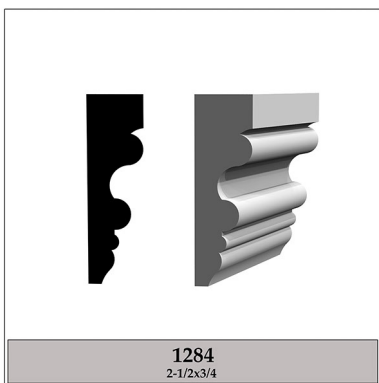

1284
2-1/2x3/4

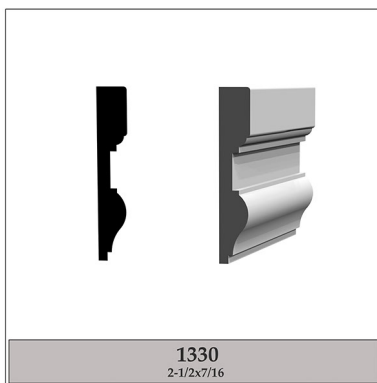

1330
2-1/2x7/16

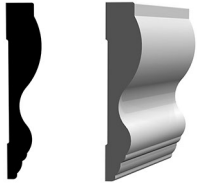

OML44A
2-3/4x35/64

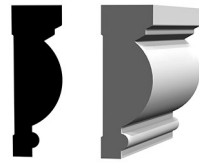

OML52
2-5/8x7/8

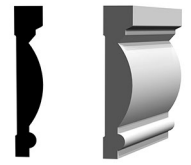

OML52A
2-5/8x1/2

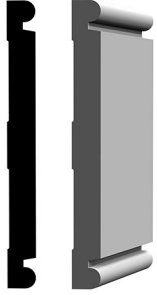

831
5x1/2

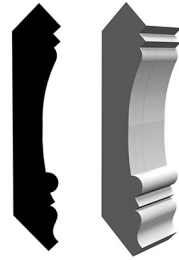

685 P
4-7/16x27/32 (3-1/4 DEPTH X 3-1/32 PROJECTION)

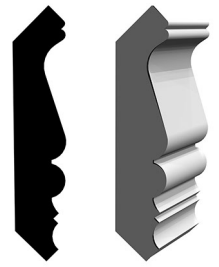

686 P
4-5/32x27/32 (2-29/32 DEPTH X 3 PROJECTION)

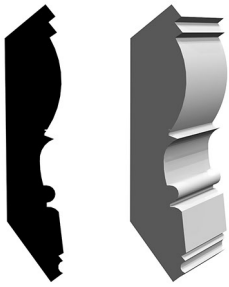

687 P
4-1/2x27/32 (3-15/32 DEPTH X 2-13/16 PROJECTION)

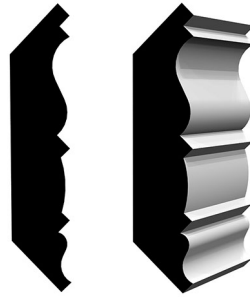

706 P
3-11/16x25/32 (2-5/8 DEPTH X 2-19/32 PROJECTION)

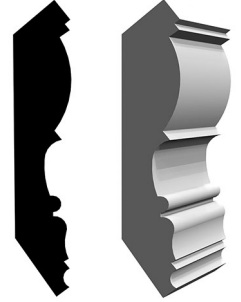

712
4-1/2x27/32 (3-9/16 DEPTH X 2-23/32 PROJECTION)

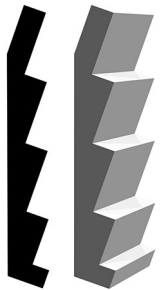

1261
5-1/2x3/4 (2-5/32 DEPTH 5-1/16 PROJECTION)



1266
5-1/2x3/4 (3-7/8 DEPTH, 3-7/8 PROJECTION)

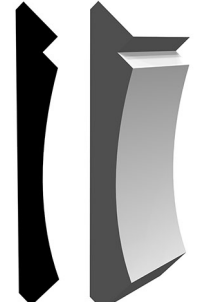

1276P
5-1/2x3/4 (DEPTH 3-15/16, PROJECTION 3-13/16)



1281P
5-1/2x3/4 (DEPTH 3-7/8, PROJECTION 3-7/8)

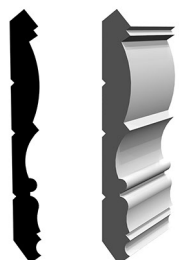

1712
4-1/2x1/2



1899B
5-1/8x29/32

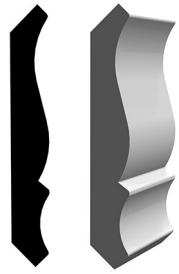

OML36
5-1/16x3/4



20511
1-1/2x3/4



10039
1-1/16x27/32

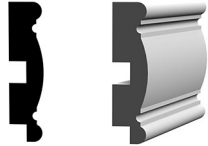

10053
2x1/2



10054
2x1/2



10055
2x1/2

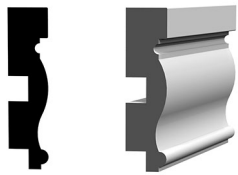

10056
2x1/2



1339
1-1/4x3/4



1535
1-1/4x5/32



1539
3/4x1/2

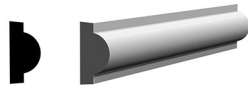

53
3/8x3/16



40
11/16x5/16

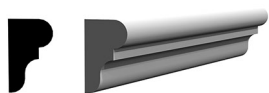

41
13/32x1/4



589
1-1/4x3/8



1230
11/32x7/32

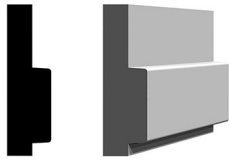

1265
1-1/2x7/16

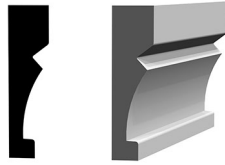

1270
1-1/2x3/4

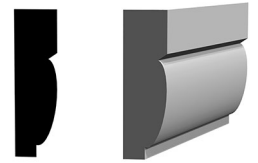

1275
1-1/2x3/4



1280
1-1/2x3/4

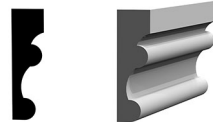

1285
1-1/2x7/16



1336
1/2x1/4



1538
1-1/2x7/16

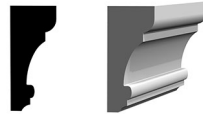

10050
1-1/2x21/32



10475
15/32x15/32



10513
5/16x5/16



10514
3/16x1/8



10517
5/8x15/32



20512
1x1

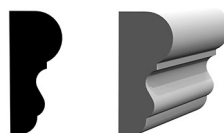

OML43
1-3/4x9/16



OML116
7/16x3/4