



NOVO

Building Products



MOULDINGS | SHEET GOODS | BOARDS | EXTERIOR MILLWORK
LAKELAND DISTRIBUTION CENTER

our STORY

DEEP ROOTS. HIGH STANDARDS. BRIGHT FUTURE.

Founded in 1946, Novo Building Products (previously known as Empire Moulding & Millwork) has grown into one of the largest millwork distribution and manufacturing

companies in the United States. With a geographic footprint that touches the majority of the eastern half of the United States, Novo Building Products is positioned for continued expansion.

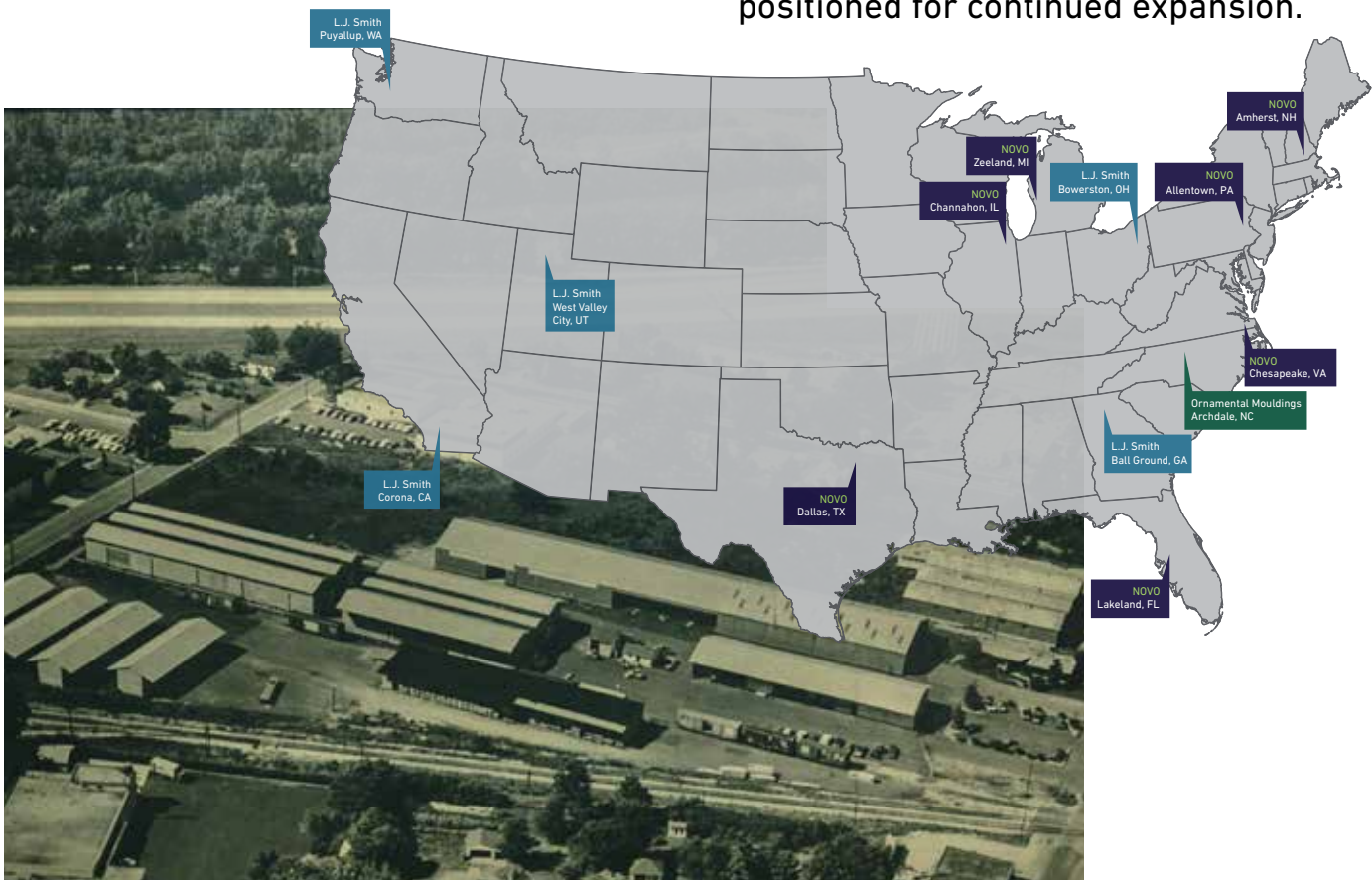

our

FAMILY

NOVO BUILDING PRODUCTS IS PROUD TO BE PART OF THE ADENTRA FAMILY.



Novo Building Products is an industry leading manufacturer and distributor of mouldings, stair parts, doors, and specialty building products. We serve building material dealers (lumberyards), door shops, retail home centers, and millwork manufacturing partners throughout the United States and parts of Canada and Mexico.

Learn more at NOVOBP.COM.

ADENTRA is one of North America's largest distributors of architectural-grade building and millwork products to the residential and commercial construction industries. Adentra currently operates a network of 86 distribution and fabrication facilities in North America consisting of five industry leading distribution brands: Hardwoods Specialty Products, Mid-Am Supply, Frank Paxton Lumber Company, Rugby Architectural Building Products, and Novo Building Products.

Learn more at ADENTRAgroup.com.







TABLE OF CONTENTS

NOVOBP.COM	6
On-line Ordering	
Inspiration	7-19
Build-Ups	20-21
Decorative Accessories	22-25
Custom Manufacturing	26
Flexible Moulding	27
Rustic Shiplap	28
Sheet Goods Program	29-31
Boards	32
MOULDING	
Casing	33-35
Stops Mullions	36
Stool Brick Mould	37
Jambs	37
Base	38-40
Base Cap	41
Chair Rail	41
Wall Panel Mould	42
Cove Bed	43
Crown	43-45
General Purpose	46
DECORATIVE MOULDING	
Crown Blocks	47
Chair Rail	47
Window & Door Blocks	47
Base Blocks	48
Casing	48
General Purpose	48
Columns	49
Parts Index	50
Quality Products	51

Achieve a similar look using: **WP4** V-Groove Wainscoting
445 Casing | **623** Base | **126** Shoe



NOVO Building Products is proud to offer a brand new efficient self-service online portal.



Full access to stocked product pricing



Easily place orders on any desktop or mobile device



Receive order status update



Follow the steps below to sign up today!

1. Locate your Customer Code from the "Ship To" line on your order acknowledgment.
2. Navigate to NOVOBP.com. Go to SIGN IN. Select "Create An Account".
3. Fill in all fields marked with "Required" and select "Create Account".
4. Allow 1 business day for account verification, and then explore the new online portal!



Style is individual, personal, and unique.
Make your room a reflection of you...

DISTINGUISH YOUR STYLE





Traditional

RANCH
CLASSIC
COLONIAL
MIDWESTERN
EARLY AMERICAN
INVITING & TIMELESS



The mouldings listed may not be as shown in the image but are represented to achieve a similar style or look:

390 Chair Rail | 52 Crown | 93 Cove | 126 Shoe | 356 Casing | 623 Base

Traditional

Traditional Mouldings enhance any home style from Midwestern to Early American to Coastal. They blend perfectly with the classic style furnishing and timeless building materials of today. NOVO has a vast selection of traditional style mouldings to match and enhance your own unique style.



**52
CROWN**
9/16 x 2-3/4



**356
CASING**
11/16 x 2-1/4



**390
CHAIR RAIL**
11/16 x 2-5/8



**623
BASE**
9/16 x 3-1/4

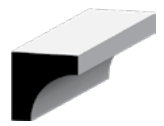

**93
COVE**
3/4 x 3/4



**126
SHOE**
1/2 x 3/4

PROFILES SHOWN ARE NOT TO SCALE.

⚠️WARNING: Drilling, sawing, sanding or machining wood products can expose you to wood dust, a substance known to the State of California to cause cancer. Avoid inhaling wood dust or use a dust mask or other safeguards for personal protection. For more information go to www.P65Warnings.ca.gov/wood

NOVOBP.COM | 800.253.9000

Contemporary

**ARTISTIC
AVANT-GARDE**

**ECLECTIC YET
SOPHISTICATED SIMPLICITY**

**FULL OF LIFE, CULTURE,
COLOR, AND TEXTURE**

**COMBINING UNIQUE, FOUND,
REPURPOSED OBJECTS, BOTH
NATURAL & MANUFACTURED
MATERIALS**



The mouldings listed may not be as shown in the image but are represented to achieve a similar style or look:

STCA Casing | Architrave made by: **1x6 S4S** & **280 Back Band (x2)**
STBA Base | **L 254 Shoe**

Contemporary

At its core, the word "contemporary" means "of the moment." Sleek & thoughtful, contemporary design spaces often feature a mixture of both straight and elegantly curved lines, which can be seen as a slight nod to this style's Art-Deco roots. Today, the look is defined by curved lines, and embraces minimalistic elements highlighting grays, beiges and shades of white. Although the contemporary trend changes with time, the basic cutting edge simplicity and idealism remains as unique as your vision.

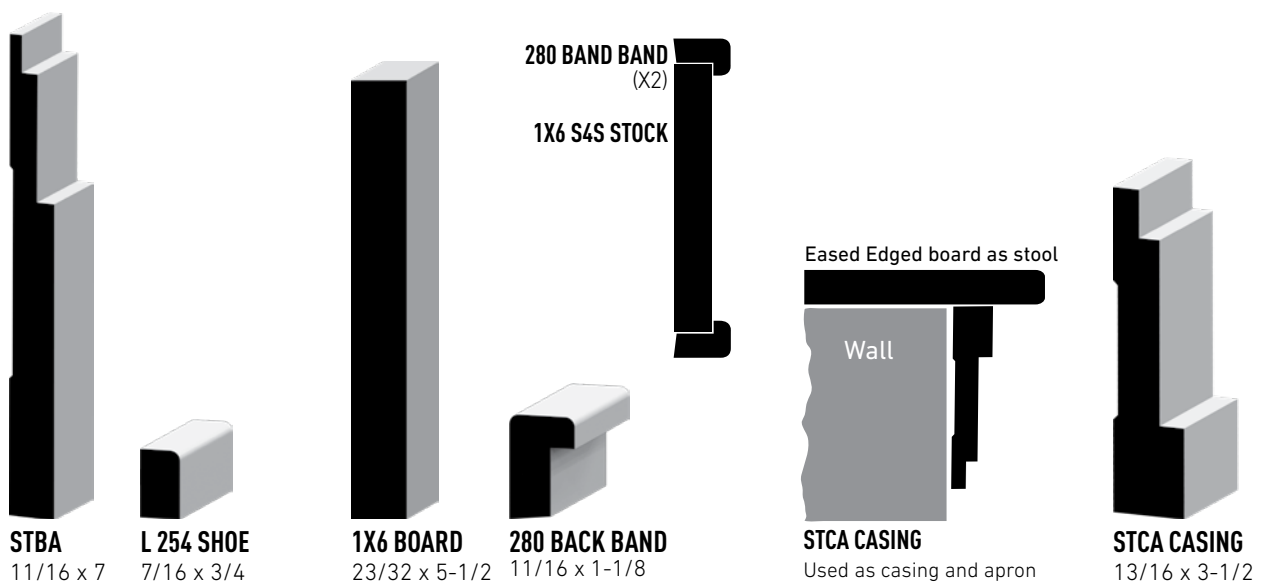

PROFILES SHOWN ARE NOT TO SCALE.

WARNING: Drilling, sawing, sanding or machining wood products can expose you to wood dust, a substance known to the State of California to cause cancer. Avoid inhaling wood dust or use a dust mask or other safeguards for personal protection. For more information go to www.P65Warnings.ca.gov/wood



Victorian

GLAMOROUS
ORNATE
ART DECO
BAROQUE
SOUTHERN PLANTATION
COLONIAL ESTATE





The mouldings listed may not be as shown in the image but are represented to achieve a similar style or look:

Crown Buildup: **L 340** Crown & **738** Base | **8412** Cap | **RB3** Casing
 Base Buildup: **738** Base & **RB3** Casing

Victorian

Victorian Mouldings hearken to the richness of old world artisan builders, craftsman and clothiers that regarded every part of their work a piece of art. It is a style that can transform the bland into a bold statement of line and form. Ornate mouldings can be combined to restore a great Painted Lady or add a subtle flair and richness to add glamour to any room in your home.

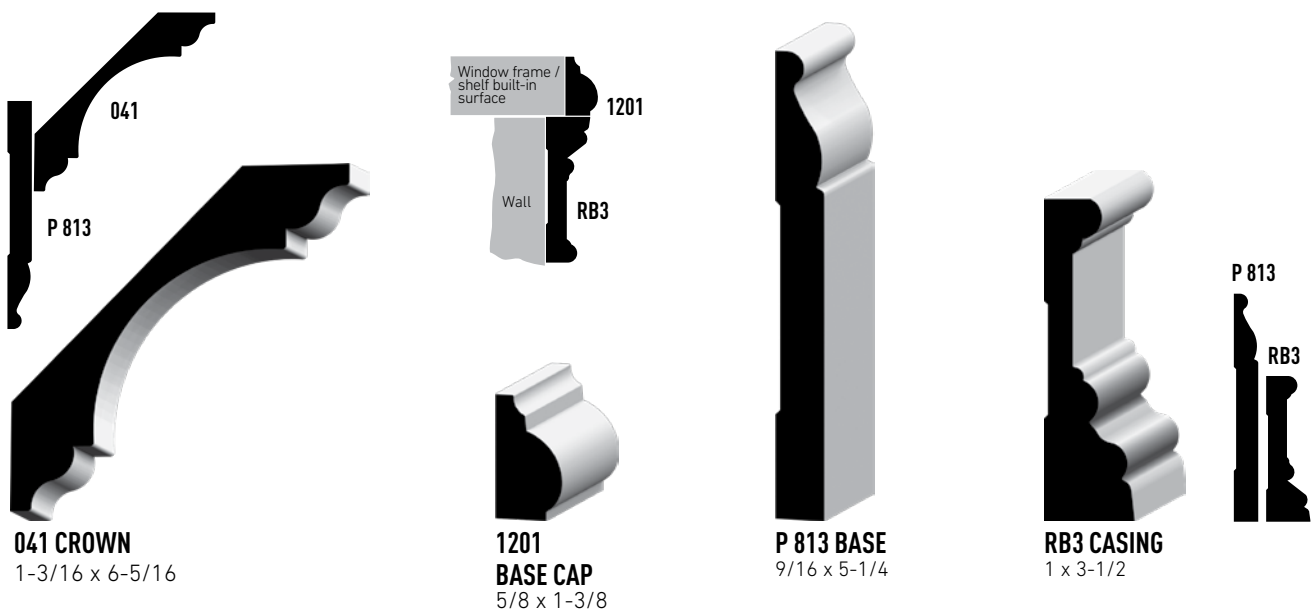

PROFILES SHOWN ARE NOT TO SCALE.

WARNING: Drilling, sawing, sanding or machining wood products can expose you to wood dust, a substance known to the State of California to cause cancer. Avoid inhaling wood dust or use a dust mask or other safeguards for personal protection. For more information go to www.P65Warnings.ca.gov/wood



Farmhouse

FARM & COTTAGE, RUSTIC & FINISHED, HANDCRAFTED & MILLED
NATURAL & PAINTED WOODS, STURDY BEAMS & HEADERS
LIVABLE LUXURY — FRONTIER SIMPLICITY...
WORK... RESTORE



The mouldings listed may not be as shown in the image but are represented to achieve a similar style or look:

B G312 Casing w/**280** Back Band Casing | **B 512** Base | **L 254** Shoe | **SL16** Shiplap
BEAMRUSTIC-8WM5X5 Faux Beam

Farmhouse

Classic, elegant and comfortable, the modern farmhouse decorating is rooted in rustic country charm peppered with warm minimalism. Striking just the right balance of pastoral and refined, modern farmhouse decor emphasizes comfort and casual living with contemporary sensibilities reflective of today's times. NOVO stocks a wide variety of hardwood and primed mouldings, boards, and wall panels from wainscoting, bead-board to shiplap; combined with faux beams from Ornamental Mouldings you can create warm and inviting spaces, from cozy to dramatic and inviting, for any family gathering.



SL16
SHIPLAP
 23/32 x 5-1/2



1X6 BOARD
 23/32 x 5-1/2



280
BACK BAND
 11/16 x 1-1/8



B G312
BEVEL GROOVED
CASING
 11/16 x 3-1/2



B G512
BEVEL GROOVED
BASE
 9/16 x 5-1/2

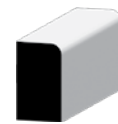

L 254 SHOE
 7/16 x 3/4



BEAMRUSTIC-8WM5X5
 Rustic Maple Beam

PROFILES SHOWN ARE NOT TO SCALE.

WARNING: Drilling, sawing, sanding or machining wood products can expose you to wood dust, a substance known to the State of California to cause cancer. Avoid inhaling wood dust or use a dust mask or other safeguards for personal protection. For more information go to www.P65Warnings.ca.gov/wood

Craftsman





**LINE & STRUCTURE
HANDCRAFTED
ARTISAN-CRAFTSMAN
MODERN-FARMHOUSE
WESTERN RANCH**

The mouldings listed may not be as shown in the image but are represented to achieve a similar style or look:

5010 Architrave | **412** Casing | **L 432** Casing w/**280** Back Band | **L 254** Shoe
L 414 E1E Base w/**280** Back Band **BEAMRUSTIC-8WM5X5** Faux Beam

Craftsman

Craftsman homes are full of endless detail and character, known for their natural materials, cozy interiors, and wide porches. Patterns and lines show the Arts & Crafts Architectural style through the use of natural woods combined with simple paint schemes. Wainscoting or beadboard detailing, and decorated ceilings with beams will help to give your home that warm feeling.

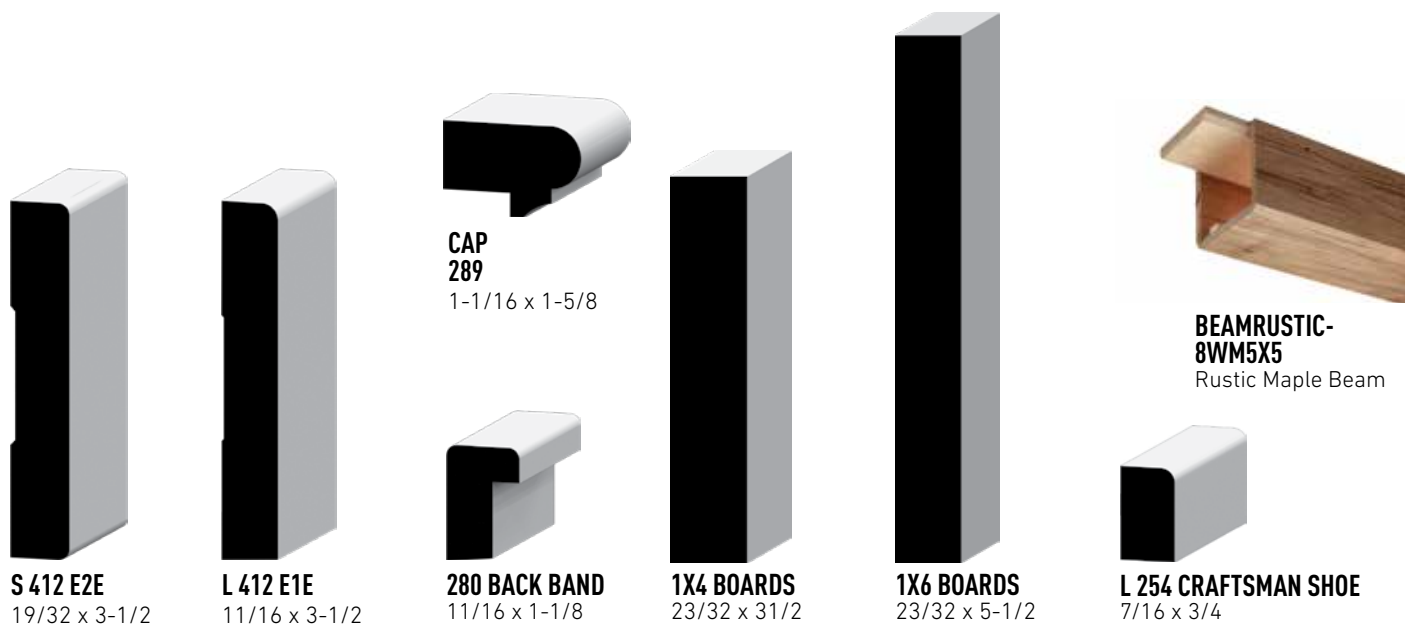

PROFILES SHOWN ARE NOT TO SCALE.

⚠️WARNING: Drilling, sawing, sanding or machining wood products can expose you to wood dust, a substance known to the State of California to cause cancer. Avoid inhaling wood dust or use a dust mask or other safeguards for personal protection. For more information go to www.P65Warnings.ca.gov/wood

Craftsman/Contemporary | Sleek, Modern, Simple



Back Band



**BACK BAND
280**
11/16 x 1-1/8
PRIMED 17'

Shoe



L 254 SHOE
7/16 x 3/4
PRIMED
8' | 12' | 16'

STCA Step Casing | STBA Step Base | L254 Craftsman Shoe
Frameport® Shaker 3-panel Craftsman door

Crown

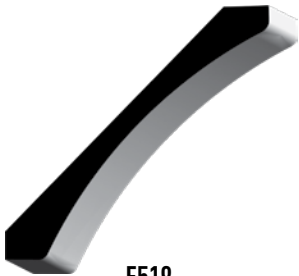

E519
9/16 x 4-1/4
MDF 16'



CR291
3/4 x 5-1/4
MDF 16'

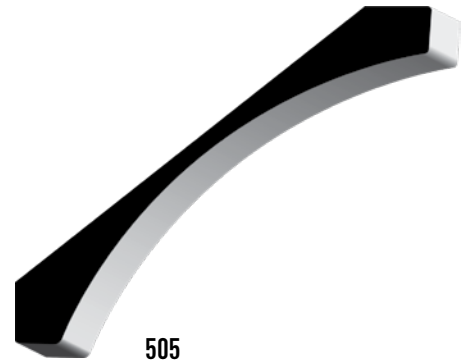

505
1 x 7
MDF 16'

Casing



**ROUND EDGE
CASING
473**
9/16 x 2-1/4
PRIMED 7' | 17'



**ROUND EDGE
CASING
453**
11/16 x 2-1/4
PRIMED 7' | 17'



**E1E CASING
L 412**
11/16 x 3-1/2
MDF 8' | 12'



**ROUND EDGE
CASING
S 412 E2E**
19/32 x 3-1/2
MDF 8' | 12'



**BEVEL GROOVED
CASING
B G312**
11/16 x 3-1/2
PRIMED 17'



**SCOOP CASING
SCCA**
13/16 x 3-1/2
PRIMED 17'

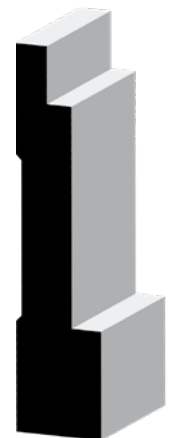

**STEP CASING
STCA**
13/16 x 3-1/2
PRIMED 17'

Craftsman/Contemporary | Sleek, Modern, Simple

Base



BEVEL GROOVED CASING
B G312
 11/16 x 3-1/2
 PRIMED 17'



BEVEL GROOVED BASE
B G512
 9/16 x 5-1/2
 PRIMED 16'



B G312 Bevel Grooved Casing | **B G512** Bevel Grooved Base
L254 Craftsman Shoe | **Frameport®** Shaker 3-panel door



SCOOP BASE
SCBA
 11/16 x 7
 PRIMED 16'



STEP BASE
STBA
 11/16 x 7
 PRIMED 16'



SCCA Scoop Casing | **SCBA** Step Base | **L254** Craftsman Shoe
Frameport® Shaker 5-panel door

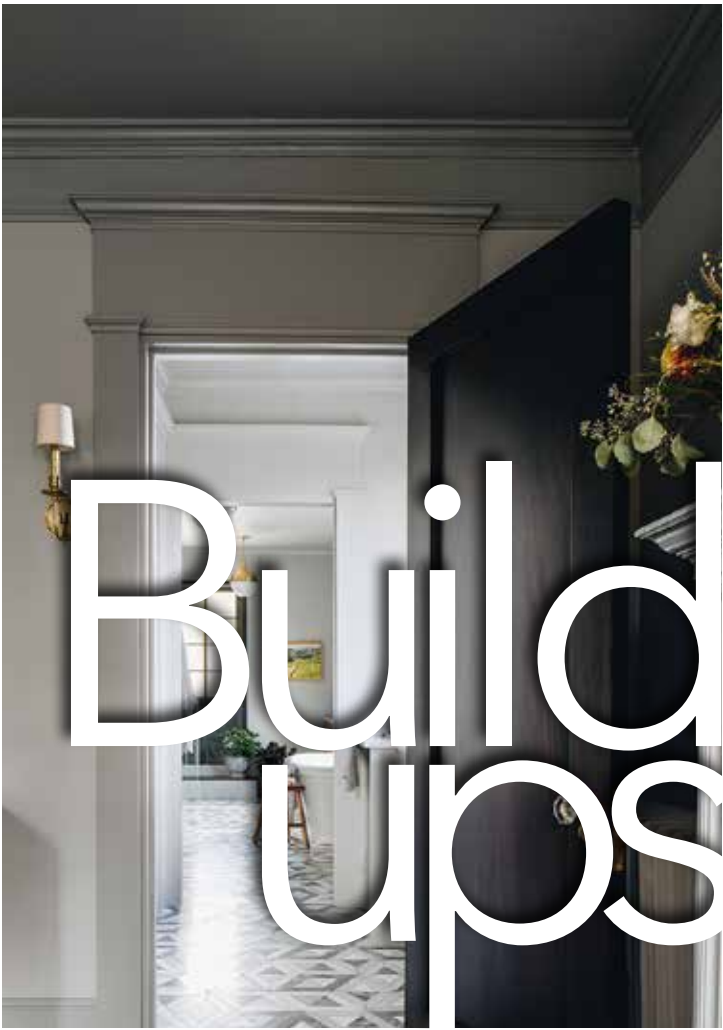

Combine moulding patterns to create a unique home style.

- Combine crowns, bases, casing, panel moulds, shoe or quarter rounds and more to create detail, line and pattern.
- Use boards or square stock to build up depth.
- Combine square and eased edges to create richer detail.
- Use moulding with the same style families for a harmonious feel.
- Create completely unique build-ups to fit your own style.



Build-Ups can dramatically change any space adding rich detail for low-cost.

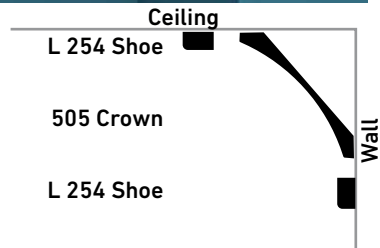
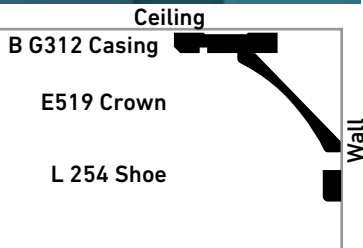

Build-Ups | Crown

Build-Up combinations are as limitless as your imagination. Create a look that is uniquely you.

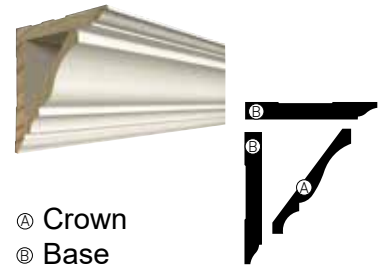
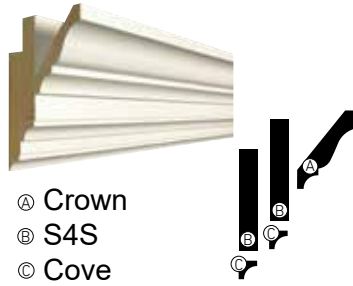

Build-Ups | Chair Rail

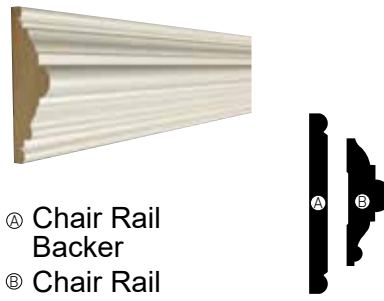

Build-Ups | Casing

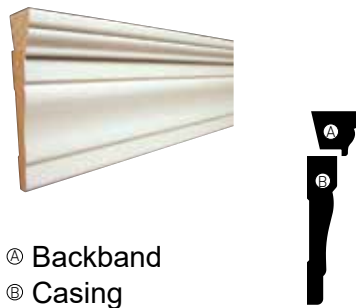

Build-Ups | Base

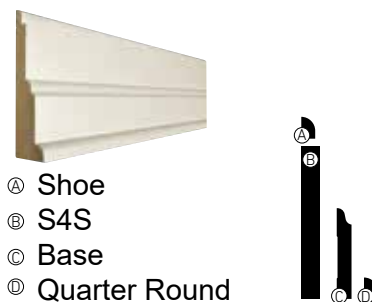
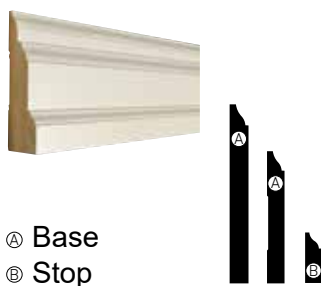

Decorative Accessories

ORNAMENTAL

DECORATIVE MILLWORK

A NOVO Building Products Company

Expressing a style comes easier and has greater impact when your choices—from ceiling to floor—are all unified. For nearly 100 years, Ornamental Mouldings has been providing distinctive, high-quality millwork to make entire living spaces more beautiful. Our decorative accessory styles inspired by tradition and shaped by the latest trends complement one another for unmatched selection, all in one place.

Mantels and Floating Shelves

Whenever people enter a room, their eyes instantly take stock of the space. Reward their gaze with our Mantels and Floating Shelves, which marry function with details that convey a discerning sensibility.



Pattern	Product	H	D	L	Species
3 Ft. Mantel	RUSTIC3WM	5	7	36	Rustic maple
4 Ft. Mantel	RUSTIC4WM	5	7	48	
5 Ft. Mantel	RUSTIC5WM	5	7	60	
6 Ft. Mantel	RUSTIC6WM	5	7	72	



3 Ft. Mantel with insert	RUSTIC3WM-01BK	5	7	36	Rustic maple with aspen insert
4 Ft. Mantel with insert	RUSTIC4WM-01BK	5	7	48	
5 Ft. Mantel with insert	RUSTIC5WM-01BK	5	7	60	
6 Ft. Mantel with insert	RUSTIC6WM-01BK	5	7	72	



4 Ft. Mantel	CLASSIC4WHW	3 3/4	7 3/4	48	WHW
5 Ft. Mantel	CLASSIC5WHW	3 3/4	7 3/4	60	WHW
6 Ft. Mantel	CLASSIC6WHW	3 3/4	7 3/4	72	WHW



5 Ft. Mantel	CLASSIC5OAK	3 3/4	7 3/4	60	Oak
6 Ft. Mantel	CLASSIC6OAK	3 3/4	7 3/4	72	Oak



Farmhouse | **OML14B, OML24C** | Mantel and Beams

Wood Beams

Practical elements like ceiling beams and wooden stairs are prime places for expressing your style. Our Wood Beams and Decorative Stair Parts give you the tools to achieve drama or convey delicate detailing.



Pattern	Product	H	W	L	Species
Prefinished gray beam	BEAMGRAY-8WH-W5X3	3	5	96	Gray WHW
Prefinished gray beam	BEAMGRAY-8WH-W5X5	5	5	96	Gray WHW

Rustic maple beam	BEAMRUSTIC-8WM5X3	3	5	96	Rustic maple
Rustic maple beam	BEAMRUSTIC-8WM5X5	5	5	96	Rustic maple

3 inch metal beam-band/bracket	BR-0003MTL	3 ⁹ / ₆₄	1 1/2	6 ⁷ / ₁₆	Metal
5 inch metal beam-band/bracket	BR-0005MTL	5 ¹⁷ / ₆₄	1 1/2	6 ⁵ / ₁₆	Metal



Decorative Boards

Create an impact that is more than meets the eye. Use our Decorative Boards to express your creativity with combinations that even at first glance speak volumes about your personal style.



Pattern	Product	W	T	L	Species
Decorative boards	A 1X2 8 MAPLE	1 1/2	7/16	96	Ambrosia Maple
	12X2 8 ORWOK	1 1/2	7/16	96	White Oak
Decorative boards eased edge two sides	12X2 8 ORPGY	1 1/2	7/16	96	Gray Stain
	12X2 8 ORPBK	1 1/2	7/16	96	Black Stain
Decorative boards	A 1X4 8 MAPLE	3 1/2	7/16	96	Ambrosia Maple
	12X4 8 ORWOK	3 1/2	7/16	96	White Oak
Decorative boards eased edge two sides	12X4 8 ORPGY	3 1/2	7/16	96	Gray Stain
	12X4 8 ORPBK	3 1/2	7/16	96	Black Stain
Decorative boards	A 1X6 8 MAPLE	5 1/2	7/16	96	Ambrosia Maple
	12X6 8 ORWOK	5 1/2	7/16	96	White Oak
Decorative boards eased edge two sides	12X6 8 ORPGY	5 1/2	7/16	96	Gray Stain
	12X6 8 ORPBK	5 1/2	7/16	96	Black Stain

All measurements are in inches. Some items may be special order. Please call for details.



Modern Farmhouse | PD001MD742PRIM

Decorative Stair Parts

Pattern	Product	H	W	T	Species
Primed MDF reversible decorative stair riser	PD001MD742PRIM	7 1/2	42	11/32	MDF
	PD001MD748PRIM	7 1/2	48	11/32	MDF



Primed/Oak reversible decorative stair riser	PD0020AK742PRIM1	7 1/2	42	11/32	Oak/Prime
	PD0020AK748PRIM1	7 1/2	48	11/32	Oak/Prime

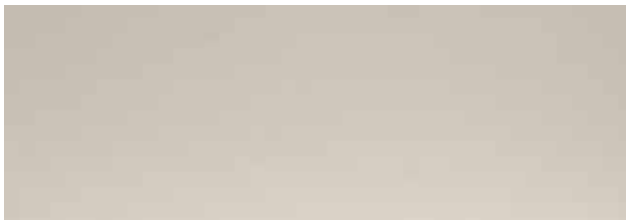

All measurements are in inches. Some items may be special order. Please call for details.

Custom Manufacturing on DEMAND

by ORNAMENTAL
DECORATIVE MILLWORK



Quality custom and short run moulding orders with quick turn around!

Custom Manufacturing
on DEMAND

Specs

- 6-16 ft. lengths (random / clear) - Prime available up to 12 ft.
- Profile max = 11-3/4" width
- Minimum run = 3,000 ft. (less than charge can be applied)
- Unique capabilities: rope, dentil, emboss, carving

Material

- Poplar
- Solid Pine
- Red Oak
- White Oak
- Alder
- Cypress
- Soft Maple
- Hard Maple
- Ambrosia "Rustic" Maple
- Others available upon request and subject to availability

Timing

- 2-3 days for cost quote and estimated lead time
- Moulding sample or CAD drawing required
- Please contact your Sales Representative



Made in the USA

ORNAMENTAL

— DECORATIVE MILLWORK —

A NOVO Building Products Company

Visit NOVOBP.COM
to order NOVO
Building Products
online





The Carter Millwork Advantage

Carter Millwork products are made of polyurethane material - a strong, long-lasting and cost-effective alternative to wood and polyester. Each piece of our moulding is individually inspected to ensure compliance to our exacting quality standards.

There are many reasons to choose Carter Millwork products:

- An extensive selection of in-stock items available for immediate shipment
- Thousands of unique profiles available
- Unlimited custom capabilities from historic replicas to contemporary designs
- Polyurethane non-shrink product for compatibility to any moulding profile
- Impervious to moisture - interior or exterior use
- Paintable or stainable - cuts like wood
- Fastest custom order turnaround in the industry
- Stock products shipped within 21 days on custom orders
- Competitive prices
- No minimum order size
- Warranty that moulding is free from defects in materials and workmanship for as long as the original purchaser owns the structure



HALF ROUND

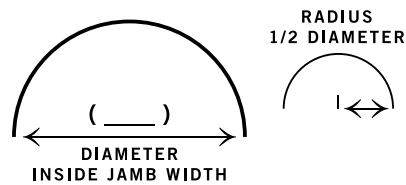

ARCS

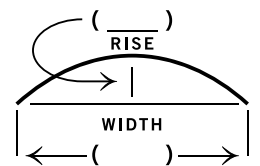

ELLIPSES

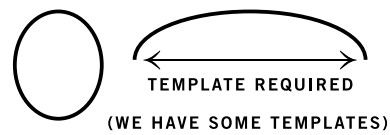

RADIUS CROWN

CONVEX-OSR
FOR CROWN & CEILING BACKER

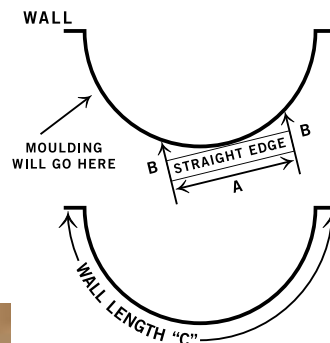

WE NEED "A" LENGTH
"B" DISTANCE & "C" LENGTH

CONCAVE-ISR
FOR CROWN & CEILING BACKER

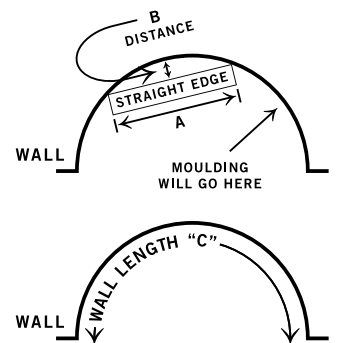

WE NEED "A" LENGTH
"B" DISTANCE & "C" LENGTH

Flexible mouldings are a special order item. Increased lead times may vary. Consult your sales representative for more information.

Rustic Nickel Gap Shiplap and Boards



Actual: 11/16-in x 5-3/8-in
SHIPLAP



Actual: 11/16-in x 3-1/2-in
TRIM BOARD

Rustic Shiplap and Trim Options

Prestained and ready to install, NOVO Rustic Shiplap will enhance any room with its warm country rugged charm. Rustic shiplap is real wood, thus each board will be slightly unique in grain pattern. Whether you use it to create an accent wall, a headboard, or to enhance an entire room, NOVO Shiplap will allow you to craft a custom designed and personally unique space.

See Sales Representative for more information about finish options, and availability.



HARDWOOD
PLYWOOD

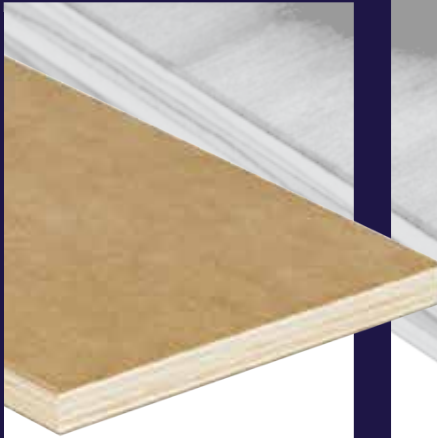

MEDIUM
DENSITY
FIBERBOARD



NOVO SHEET GOODS PROGRAM

PREMIUM SHEETS FOR HUNDREDS
OF INTERIOR APPLICATIONS

WIDE SELECTION OF SKU OFFERINGS

DELIVERED ON YOUR NEXT TRUCK ALONG
WITH YOUR MOULDING AND MILLWORK

NOVOBP.COM | 800.253.9000



Sheet Goods

Premium Hardwood - Plywood

NOVO SKU	SPECIE	THICKNESS (IMPERIAL)	THICKNESS (METRIC)	GRADE	SIZE
BIRCH					
144 8 BCPLY	Domestic Natural WPF	1/4"	N/A	A4	48" x 96"
124 8 BCPLY	Domestic Natural WPF	1/2"	N/A	A1	48" x 96"
344 8 BCPLY	Domestic Natural WPF	3/4"	N/A	A1	48" x 96"
M 524 8 BCPLY	Cabinet Grade White	1/4"	5.2mm	C4	48" x 96"
M 124 8 BCPLY	Cabinet Grade White	1/2"	12mm	C2	48" x 96"
M 184 8 BCPLY	Cabinet Grade White	3/4"	18mm	C2	48" x 96"
OAK					
144 8 OKPLY	Domestic WPF	1/4"	N/A	A4	48" x 96"
124 8 OKPLY	Domestic WPF	1/2"	N/A	A1	48" x 96"
344 8 OKPLY	Domestic WPF	3/4"	N/A	A1	48" x 96"
MAPLE					
T 124 8 MPPLY	White UV 2 sides	1/2" UV2S	N/A	Premium	48" x 96"
T 344 8 MPPLY	White UV 2 sides	3/4" UV2S	N/A	Premium	48" x 96"
344 8 MPPLY	White	3/4"	N/A	Premium	48" x 96"
MERANTI (LAUAN)					
M 524 8 MRPLY	Meranti	1/4"	5.2mm	OVL/BTR	48" x 96"
PINE					
144 8 PNPLY	Pine	1/4"	6.5mm	AC	48" x 96"
384 8 PNPLY	Pine	3/8"	9mm	AC	48" x 96"
124 8 PNPLY	Pine	1/2"	12mm	AC	48" x 96"
344 8 PNPLY	Pine	3/4"	18mm	AC	48" x 96"

🌿 ALL NOVO HARDWOOD PLYWOOD SHEETS MEET OR EXCEED HPVA SPECIFICATIONS

Some products available January 2024. Contact Sales representative for availability and lead time.



Sheet Goods Medium Density Fiberboard

NOVO SKU	SPECIE	THICKNESS (IMPERIAL)	THICKNESS (METRIC)	GRADE	SIZE
FIBERBOARD					
M 554 8 MDPLY	Ultra-Lite MDF	1/4"	5.5mm	N/A	48" x 96"
M 94 8 MDPLY	Ultra-Lite MDF	3/8"	9mm	N/A	48" x 96"
M 124 8 MDPLY	Ultra-Lite MDF	1/2"	12mm	N/A	48" x 96"
M 184 8 MDPLY	Ultra-Lite MDF	3/4"	18mm	N/A	48" x 96"

🌿 ALL NOVO MDF SHEETS ARE TSCA IV COMPLIANT and CARB APPROVED

Some products available January 2024. Contact Sales representative for availability and lead time.

⚠️WARNING: Drilling, sawing, sanding or machining wood products can expose you to wood dust, a substance known to the State of California to cause cancer. Avoid inhaling wood dust or use a dust mask or other safeguards for personal protection. For more information go to www.P65Warnings.ca.gov/wood

Boards



Specified lengths available

PRIMED FJ POPLAR		
1X4	3/4 x 3-1/2	17'
1X6	3/4 x 5-1/2	16'
1X8	3/4 x 7-1/4	16'
1X12	3/4 x 11-1/4	16'

SOFTWOOD MDF S4S			
1X2	11/16 x 1-1/2	PRIMED	16'
1X4	3/4 x 3-1/2	PINE	8' 10' 12' 14' 16'
	23/32 x 3-1/2	PRIMED	8'6" 16' 17'
	11/16 x 3-1/2	MDF	7'
1X6	3/4 x 5-1/2	PINE	8' 10' 12' 14' 16'
	23/32 x 5-1/2	PRIMED	16'
	11/16 x 5-1/2	MDF	16'
1X8	3/4 x 7-1/4	PINE	8' 10' 12' 14' 16'
	23/32 x 7-1/4	PRIMED	16'
	11/16 x 7-1/4	MDF	16'
1X10	3/4 x 9-1/4	PINE	8' 10' 12' 14' 16'
	23/32 x 9-1/4	PRIMED	16'
1X12	3/4 x 11-1/4	PINE	8' 10' 12' 14' 16'
	23/32 x 11-1/4	PRIMED	16'
	11/16 x 11-1/4	MDF	16' 18'
5/4X4	1-1/16 x 3-1/2	PRIMED	16'
5/4X6	1-1/16 x 5-1/2	PRIMED	16'
5/4X8	1-1/16 x 7-1/4	PRIMED	16'
5/4X12	1-1/16 x 11-1/4	PRIMED	16'

MICRO EASED EDGE			
E 1X3	21/32 x 2-1/2	PRIMED	17'
E 1X4	21/32 x 3-1/2	PRIMED	16' 17'
E 1X6	21/32 x 5-1/2	PRIMED	16'
E 1X8	21/32 x 7-1/4	PRIMED	16'
E 1X10	21/32 x 9-1/4	PRIMED	16'
E 1X12	21/32 x 11-1/4	PRIMED	16'

HARDWOOD			
1X4	3/4 x 3-1/2	POPLAR	8' 10' 12'
		OAK	8' 12'
1X6	3/4 x 5-1/2	POPLAR	8' 10' 12'
		OAK	8' 12'
1X8	3/4 x 7-1/4	POPLAR	8' 10' 12'
		OAK	8' 12' 16'
1X10	3/4 x 9-1/4	POPLAR	8' 10' 12'
1X12	3/4 x 11-1/4	POPLAR	8' 10' 12'
		OAK	12'

Casing



**MODERN CASING
327**
11/16 x 2-1/4
PINE 7' | 10' | RL
PRIMED 7' | 8'6" | 17'
19/32 x 2-1/4
MDF 7' | 10'



**COLONIAL CASING
356**
11/16 x 2-1/4
PINE 7'
PRIMED 8'6" | 17'



**COLONIAL CASING
366**
11/16 x 2-1/4
PINE 7' | RL
PRIMED 7' | 8'6" | 17'



**COLONIAL CASING
376**
11/16 x 2-1/4
PRIMED 8'6" | 17'



**BABY HOWE CASING
B RB3**
11/16 x 2-1/4
PRIMED 7' | 8'6" | 17'



**ROUND EDGE CASING
473**
9/16 x 2-1/4
PRIMED 7' | 17'



**ROUND EDGE CASING
453**
11/16 x 2-1/4
PRIMED 7' | 17'



**COLONIAL CASING
443**
5/8 x 3-1/4
PRIMED 8' | 12' | 16'



**VICTORIAN CASING
L G217**
11/16 x 3-1/4
PRIMED 17'



**COLONIAL CASING
H 444**
11/16 x 3-1/4
PRIMED 8'6" | 17'



**BEADED CASING
445**
11/16 x 3-1/4
PINE RL
PRIMED 7'3" | 8'6" | 17'

Casing



**HOWE CASING
M RB3**
11/16 x 3-1/4
PRIMED 8'6" | 17'



**COLONIAL CASING
3180**
7/8 x 3-1/4
PRIMED 7'6" | 8'6" | 17'



**FLUTED/REEDED
REVERSIBLE
L 338**
9/16 x 3-3/8
MDF 8'



**FLUTED/REEDED
CASING
M 15**
11/16 x 3-1/2
PRIMED 17'



**VICTORIAN CASING
VICC**
11/16 x 3-1/2
PRIMED 17'



**FLAGLER CASING
350**
13/16 x 3-1/2
PRIMED 17'



**HOWE CASING
RB3**
1-1/16 x 3-1/2
PINE RL
PRIMED 7'6" | 8'6" | 17'



**S4S CASING
S 312**
9/16 x 3-1/2
PRIMED 17'



L 412 E1E CASING
11/16 x 3-1/2
MDF 8' | 12'



S 412 E2E CASING
19/32 x 3-1/2
MDF 8' | 12'



B G312 BEVEL GROOVED CASING
11/16 x 3-1/2
PRIMED 8'6" | 17'



SCCA SCOOP CASING
13/16 x 3-1/2
PRIMED 8'6" | 17'

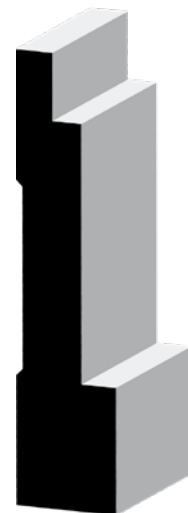

STCA STEP CASING
13/16 x 3-1/2
PRIMED 8'6" | 17'

Stops | Mullions



COLONIAL STOP
951
 3/8 x 3/4
 PINE 7'



COLONIAL STOP
947
 3/8 x 1-1/4
 PINE 7' | 10'
 PRIMED 7'



MODERN STOP
827
 3/8 x 1-1/4
 PINE 7'



S4S E2E STOP
L 887
 3/8 x 1-1/4
 PINE 7'



S4S E1E STOP
887
 3/8 x 1-1/4
 PRIMED 7' | 8'6"
 MDF 8'3"



MODERN STOP
856
 3/8 x 1-3/8
 PRIMED 7'



E1E STOP
886
 3/8 x 1-3/8
 PRIMED 7' | 8'2"



OGEE STOP
916
 3/8 x 1-3/8
 PRIMED 7' | 8'6" | 17'
 MDF 8'6"



COLONIAL MULLION
L 984
 3/8 x 1-1/8
 PRIMED 8'6"



COLONIAL MULLION
L 988
 3/8 x 1-1/2
 PINE 8'



COLONIAL MULLION
988
 3/8 x 1-3/4
 PINE RL



COLONIAL MULLION
982
 3/8 x 2
 PINE 8'

Stool | Brickmould | Jambs



STOOL 1021

11/16 x 5-1/4
PRIMED 16'

7 1021

11/16 x 7-1/4
PRIMED 16'
19/32 x 7-1/4
MDF 16'



BRICK MOULD 180

1-1/4 x 2
PRIMED 7' | 17'
PVC 7' | 17'

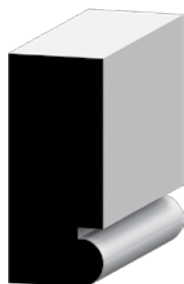

BRICK MOULD L 176

11/16 x 1-5/8
PRIMED 7' | 8' | 17'
PVC 7' | 17'



SHINGLE MOULD L210

5/8 x 1-5/8
PRIMED 8'



APRON MOULD B2

11/16 x 2-1/2
PRIMED 16'

LAKELAND IN STOCK JAMBS

NOVO SKU	(L)	SPECIES	DESCRIPTION
458 68 FJPMN	6'8"	FINGER JOINT PRIMED PINE	11/16 X 4-5/8 FLAT JAMB PAIR 81" BD
458 80 FJPMN	8'	FINGER JOINT PRIMED PINE	11/16 X 4-5/8 FLAT JAMB PAIR 97" BD
478 68 FJPMN	6'8"	FINGER JOINT PRIMED PINE	11/16 X 4-7/8 FLAT JAMB PAIR 81" BD
478 80 FJPMN	8'	FINGER JOINT PRIMED PINE	11/16 X 4-7/8 FLAT JAMB PAIR 97" BD
514 68 FJPMN	6'8"	FINGER JOINT PRIMED PINE	11/16 X 5-1/4 X 6-9 FLAT JAMB PAIR 81" BD
514 80 FJPMN	8'	FINGER JOINT PRIMED PINE	11/16 X 5-1/4 X 8-0 FLAT JAMB PAIR 97" BD
714 80 FJPMN	8'	FINGER JOINT PRIMED PINE	11/16 X 7-1/4 X 8-0 FLAT JAMB PAIR 97" BD
SPLIT JAMBS			
2 4916 68 SPTFP	6'8"	FINGER JOINT PRIMED PINE	SPLIT JAMB 4-9/16 2-3/4F X 2-1/2M X 6-8
2 4916 80 SPTFP	8'	FINGER JOINT PRIMED PINE	SPLIT JAMB 4-9/16 2-3/4F X 2-1/2 X 8-0
514 68 SPTFP	6'8"	FINGER JOINT PRIMED PINE	1-1/16 X 2-3/4 SPLIT JAMB PAIR
514 80 SPTFP	8'	FINGER JOINT PRIMED PINE	1-1/16 X 2-3/4 SPLIT JAMB PAIR

LAKELAND IN STOCK EXTERIOR FRAMES

NOVO SKU	(L)	SPECIES	DESCRIPTION
4916 68 EXPMD	6'8"	FINGER JOINT PRIMED	EXT FRM SRK 5/4 X 4-9/16 X 82-3/40A
4916 80 EXPMD	8'	FINGER JOINT PRIMED	EXT FRM SRK 5/4 X 4-9/16 X 98-3/40A
6916 68 EXPMD	6'8"	FINGER JOINT PRIMED	EXT FRM SRK 5/4X6-9/16 15/16SD X 82-3/40A
6916 80 EXPMD	8'	FINGER JOINT PRIMED	EXT FRM SRK 5/4X6-9/16 15/16SD X 98-3/40A
4916 80 EXP20	8'	FINGER JOINT PRIMED	0 MIN STAMP FJ PRMD SRK 5/4 X 4-9/16 X 82-3/40A
P4916 68 CMPST	6'8"	EXTERIOR PRIMED COMPOSITE	COMPOSITE SRK 1-1/4 X 4-9/16 X 6-8
P4916 80 CMPST	8'	EXTERIOR PRIMED COMPOSITE	COMPOSITE SRK 1-1/4 X 4-9/16 X 8-0
P6916 68 CMPST	6'8"	EXTERIOR PRIMED COMPOSITE	COMPOSITE SRK 1-1/4 X 6-9/16 X 6-8
P6916 80 CMPST	8'	EXTERIOR PRIMED COMPOSITE	COMPOSITE SRK 1-1/4 X 6-9/16 X 8-0

- AVAILABLE IN PVC / COMPOSITE BY REQUEST
 - WARRANTIED FRAME DEFENSE JAMB
- AVAILABLE TO CUSTOMER SPECIFICATIONS BY REQUEST

Base



**MODERN BASE
L 726**
7/16 x 2-1/4
PRIMED 12'



**OGEE BASE
623**
9/16 x 3-1/4
PINE RL
PRIMED 16'



**CRAFTSMAN BASE
433**
9/16 x 3-1/4
PRIMED 16'



**MODERN BASE
713**
9/16 x 3-1/4
PINE RL
PRIMED 16'

Pair with 366
Casing



**COLONIAL BASE
631**
9/16 x 3-1/4
PINE 8' | 12'
PRIMED 16'



**OGEE BASE
620**
9/16 x 4-1/4
PRIMED 16'



**COLONIAL BASE
L 163E**
9/16 x 5-1/4
PRIMED 16'



**OGEE BASE
618**
9/16 x 5-1/4
PINE RL
PRIMED 16'



**COLONIAL BASE
W 631**
9/16 x 5-1/4
PRIMED 16'



**VICTORIAN BASE
8189**
11/16 x 5-1/4
PRIMED 16'



**VICTORIAN BASE
L 8189**
9/16 x 5-1/4
PRIMED 16'



**COLONIAL BASE
L 217E**
9/16 x 5-1/4
PRIMED 16'



**COLONIAL BASE
218**
9/16 x 5-1/4
PRIMED 16'



**VICTORIAN BASE
L 5180**
9/16 x 5-1/4
PINE RL
PRIMED 16'
19/32 x 5-1/4
MDF 16'



**VICTORIAN BASE
5180**
11/16 x 5-1/4
PRIMED 16'



**VICTORIAN BASE
B312**
(15mm) 19/32 x 5-1/4
MDF 17'



**COLONIAL BASE
P 813**
9/16 x 5-1/4
PRIMED 16'

Base



**BEVEL GROOVED BASE
B G512**
9/16 x 5-1/2
PRIMED 16'



**S4S BASE
S 512**
9/16 x 5-1/2
PRIMED 16'



**SCOOP BASE
SCBA**
11/16 x 7
PRIMED 16'



**STEP BASE
STBA**
11/16 x 7
PRIMED 16'



**VICTORIAN BASE
B 615**
11/16 x 7-1/4
PRIMED 16'



**COLONIAL BASE
5187**
19/32 x 7-1/4
MDF 16'



**S4S BASE
S 712**
9/16 x 7-1/4
PRIMED 16'

Base Cap



**BASE CAP
1207**
11/16 x 7/8
PINE RL



**BASE CAP
1201**
11/16 x 1-1/4
PINE 8' | RL



**BASE CAP
163**
11/16 x 1-3/8
PINE RL
PRIMED 16'



**BASE CAP
42C**
1-1/16 x 1-5/8
PRIMED 16'

Chair Rail



**CHAIR RAIL
392**
1 x 2-3/8
PRIMED 17'



**CHAIR RAIL
390**
11/16 x 2-5/8
PINE 8'
PRIMED 16'



**CHAIR RAIL
297**
11/16 x 3
PRIMED 16'



**CHAIR RAIL
300**
1-1/16 x 3
PRIMED 16'



**CHAIR RAIL
397**
1 x 3-1/2
PRIMED POPLAR 8' | 16'



**CHAIR RAIL BACKER
L 956W**
7/16 x 4-1/4
PRIMED 16'
W 956W
9/16 x 5-1/4
PRIMED 16'

Wall | Panel Mould



JOINT MOULD
1215
9/16 x 1-1/4
PINE RL



PANEL MOULD
1217
1/2 x 1-1/2
PINE RL



PICTURE MOULD
273
11/16 x 1-3/4
PRIMED 16'



PLY CAP
1219
11/16 x 1-5/8
PINE RL

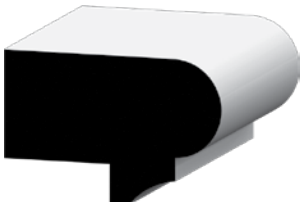

CAP
289
1-1/16 x 1-5/8
PINE RL



BACK BAND
280
11/16 x 1-1/8
PRIMED 17'

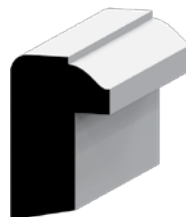

BACK BAND
281
11/16 x 1-1/8
PINE RL
PRIMED 8'6" | 17'



V-GROOVE
WAINSCOTING
WP4
23/32 x 5-1/2
PRIMED 16'



NICKEL GAP
SHIP-LAP BOARD
16SL
23/32 x 5-1/2
PRIMED 16'



NICKEL GAP
SHIP-LAP BOARD
18SL
23/32 x 7-1/4
PRIMED 16'

Crown | Cove | Bed

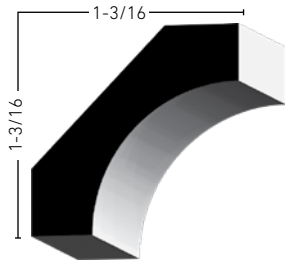

**COVE
86**
9/16 x 1-5/8
PINE 8' | RL

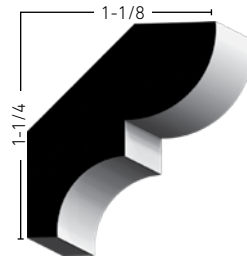

**BED MOULD
75**
9/16 x 1-5/8
PINE RL
PRIMED 8 | 16'

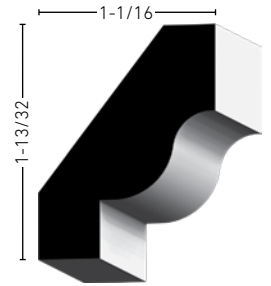

**CROWN
60**
9/16 x 1-3/4
PINE RL

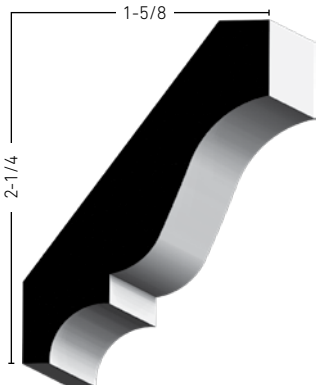

**CROWN
52**
9/16 x 2-3/4
PINE 8' | 12'
PRIMED 16'

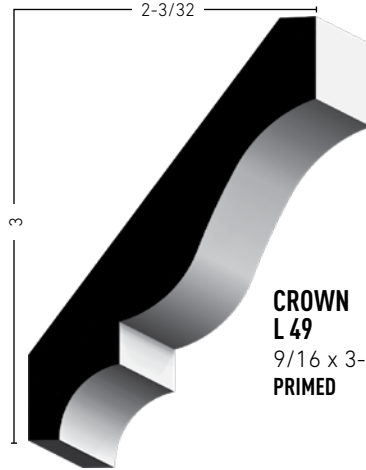

**CROWN
L 49**
9/16 x 3-5/8
PRIMED 16'

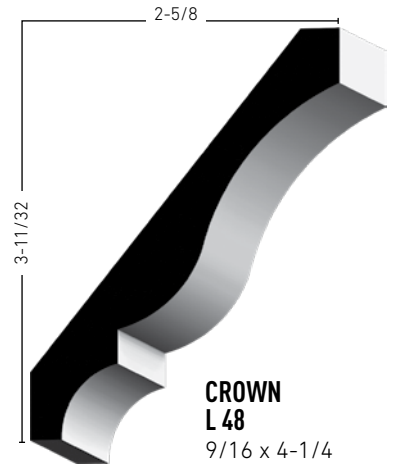

**CROWN
L 48**
9/16 x 4-1/4
PRIMED 16'

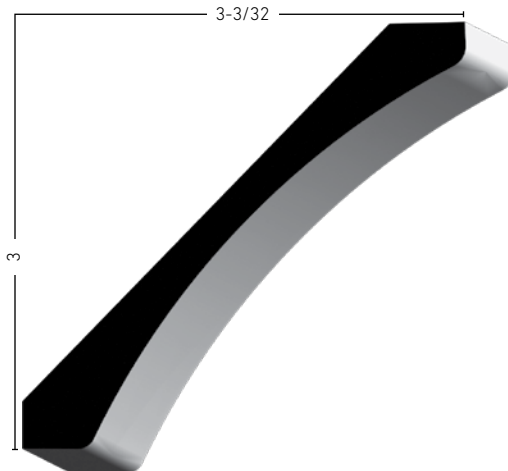

**CROWN
E519**
9/16 x 4-1/4
MDF 16'

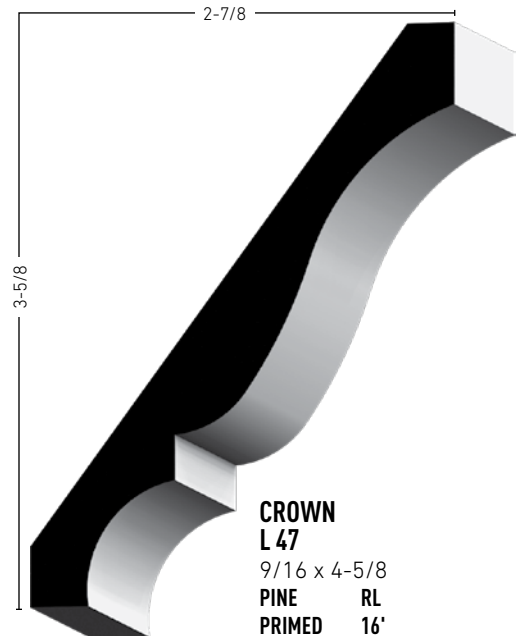

**CROWN
L 47**
9/16 x 4-5/8
PINE RL
PRIMED 16'

Crown

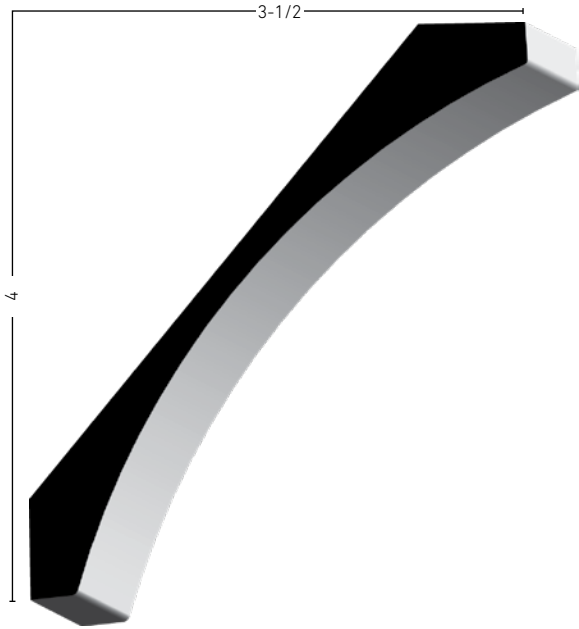

**CROWN
C R291**
3/4 x 5-1/4
MDF 16'

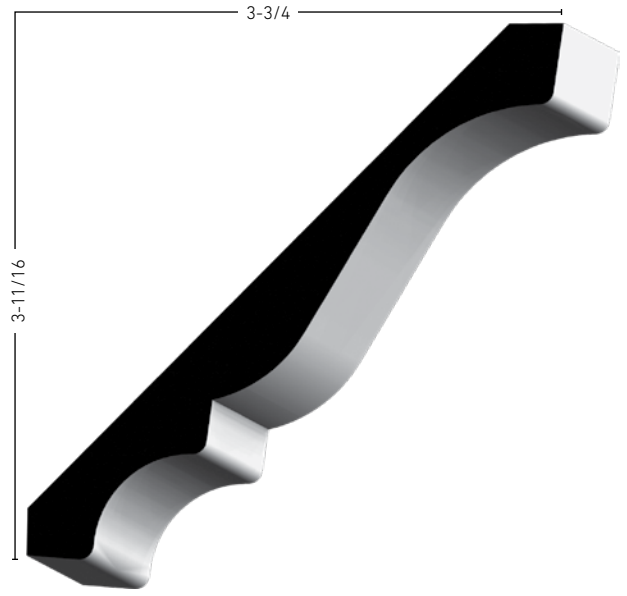

**CROWN
L 45**
19/32 x 5-1/4
MDF 16'

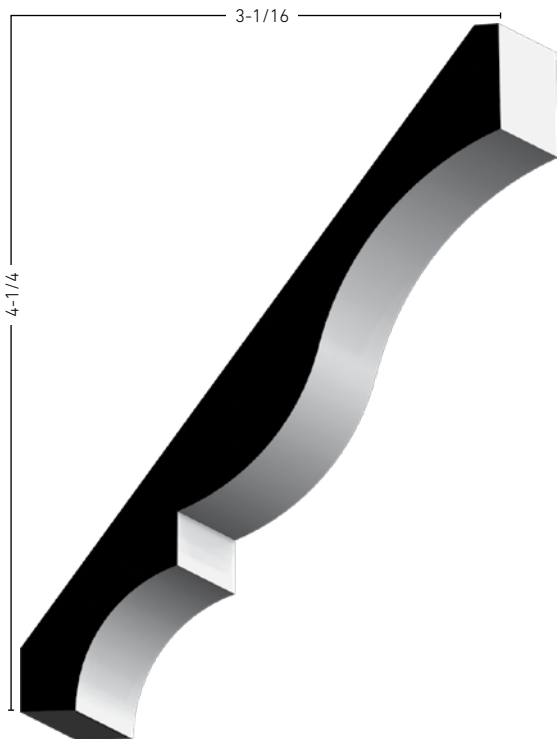

**CROWN
L 46**
9/16 x 5-1/4
PINE RL
PRIMED 8' | 16'

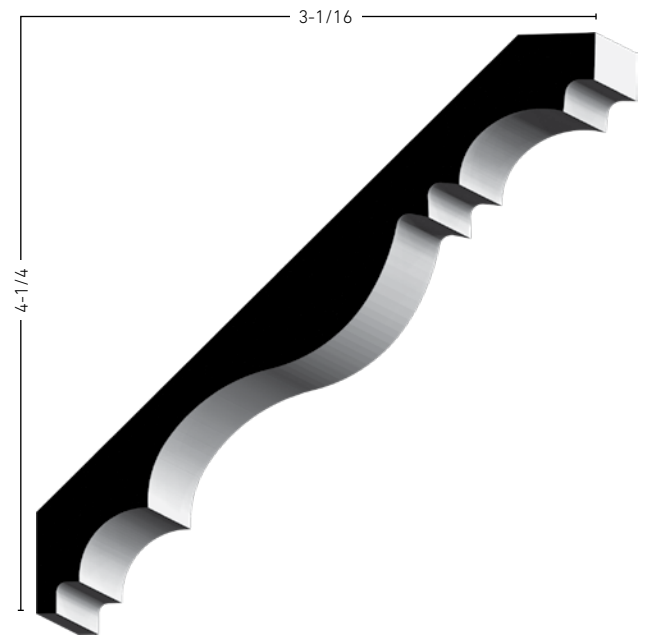

**CROWN
C 614**
11/16 x 6-1/4
PRIMED 16'

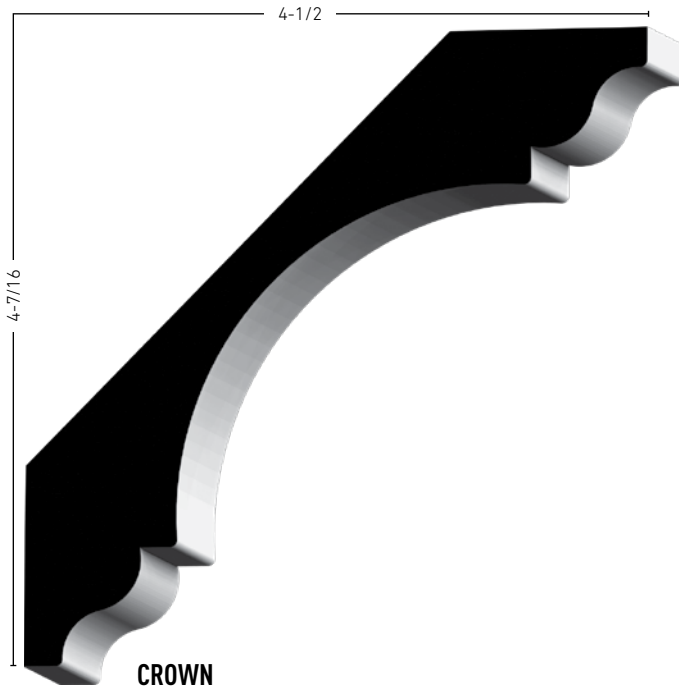

**CROWN
041**
1-3/16 x 6-5/16
MDF 16'

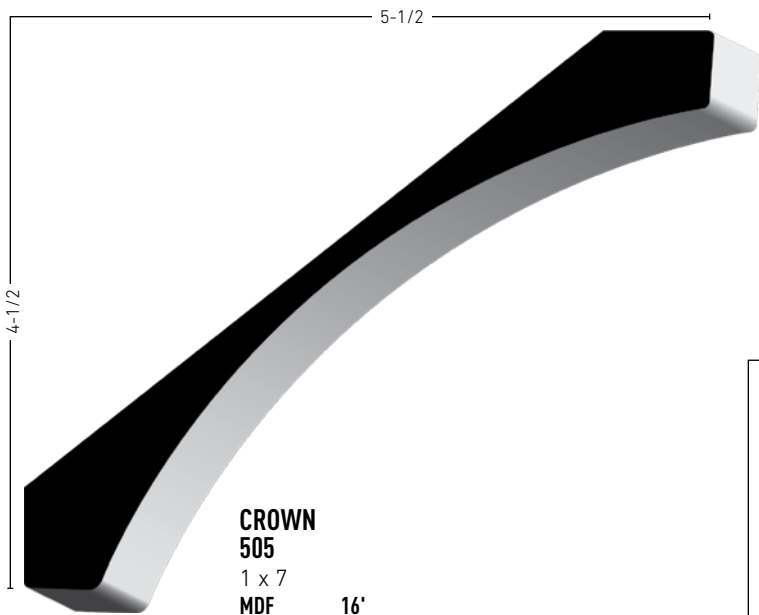

**CROWN
505**
1 x 7
MDF 16'

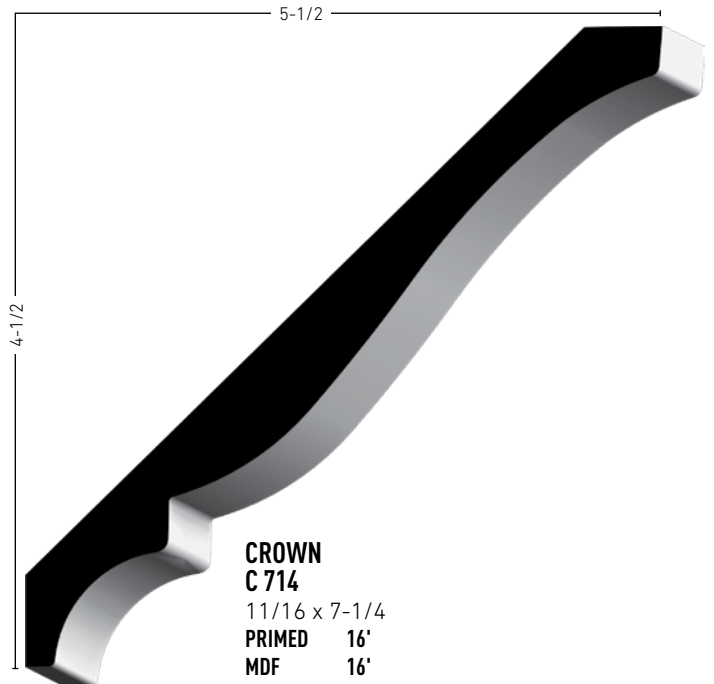

**CROWN
C 714**
11/16 x 7-1/4
PRIMED 16'
MDF 16'

General Purpose

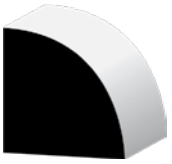

QUARTER ROUND
103
 1-1/16 x 1-1/16
 PINE RL

105
 3/4 x 3/4
 OAK 8'

106
 11/16 x 11/16
 PINE RL
 PRIMED 16'

108
 1/2 x 1/2
 PINE RL



SHOE
126
 1/2 x 3/4
 OAK 8'

129
 7/16 x 11/16
 PINE 16'
 PRIMED 16'

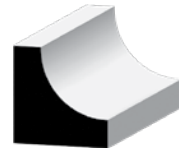

COVE
93
 3/4 x 3/4
 OAK 8'

100
 11/16 x 11/16
 PINE RL
 PRIMED 16'

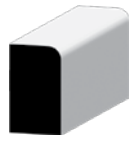

L 254 SHOE
 7/16 x 3/4
 PRIMED 16'

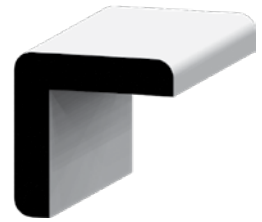

CORNER GUARD
205
 1-1/8 x 1-1/8
 PINE RL
 PRIMED 8'

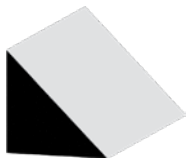

CHAMFER
995
 3/4 x 3/4
 PINE RL



FLAT SCREEN MOULD
142
 1/4 x 3/4
 PINE RL

206
 3/4 x 3/4
 PINE RL



LATTICE
L 266
 1/4 x 1-1/2
 PINE RL
 PRIMED 16'
 PVC 16'

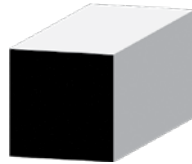

SQUARE
239
 3/4 x 3/4
 PINE 8'



CHECK STOP
254
 1/2 x 3/4
 PINE RL



HALF ROUND
123
 5/16 x 5/8
 PINE 8'

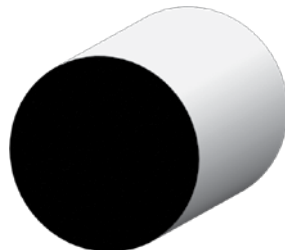

CLOSET POLE
L 233
 1-1/4 Full Round
 SPINE 16'



HAND RAIL
240
 1-1/4 x 2-1/4
 PRIMED 18'
 SPINE 16'

Decorative Moulding | Crown Blocks



LARGE INSIDE CORNER
FOR CROWN UP TO 5-1/4"
1899 IS 4-3/16 x 3-11/16 x 7-3/4
WHITE WOOD

MEDIUM INSIDE CORNER
FOR CROWN UP TO 3-7/8"
1898 IS 3-1/8 x 2-27/32 x 5-7/8
WHITE WOOD

SMALL INSIDE CORNER
FOR CROWN UP TO 3"
1897 IS 2-3/8 x 2-1/64 x 4-1/8
WHITE WOOD



MEDIUM OUTSIDE CORNER
FOR CROWN UP TO 3-7/8"
1888 OS 5-5/8 x 7-3/4 x 6-1/4
PRIMED



MEDIUM OUTSIDE CORNER
FOR CROWN UP TO 3-7/8"
1889 OS 7-1/2 x 10 x 8
PINE

Chair Rail



LEAF & BALL CHAIR RAIL
1825 1/2 x 2-1/4 x 8'
WHITE WOOD



EGG & DART CHAIR RAIL
1691 27/32 x 2-1/4 x 8'
WHITE WOOD

Window & Door Blocks



CORNER BLOCK
B 642 5/8 x 2-1/2 x 2-1/2
WHITE WOOD



CORNER BLOCK
B 740 27/32 x 4-1/2 x 4-1/2
WHITE WOOD



CORNER BLOCK
B 871 1-1/16 x 3-1/2 x 3-1/2
WHITE WOOD



CORNER BLOCK
B 915 27/32 x 2-1/2 x 2-1/2
WHITE WOOD



STAR BLOCK
B 1200 1-1/16 x 3-1/2 x 3-1/2
WHITE WOOD



CORNER BLOCK
1402 C 7/8 x 3-3/4 x 3-3/4
PRIMED POPLAR



PLINTH BLOCK
B 887 27/32 x 2-1/2 x 5-3/4
WHITE WOOD



PLINTH BLOCK
1403 7/8 x 3-3/4 x 6
PRIMED POPLAR



PLINTH BLOCK
B 742 1-1/16 x 3-1/2 x 6-1/2
WHITE WOOD



PLINTH BLOCK
B 743 1-1/16 x 4-1/2 x 8
WHITE WOOD

Decorative Moulding | Base Blocks



INSIDE BASE CORNER
B 895 IS
 7/8 x 7/8 x 6-3/4
 WHITE WOOD

OUTSIDE BASE CORNER
B 892 OS
 1-1/8 x 1-1/8 x 6-3/4
 WHITE WOOD



ROPE CASING
1124 1/2 x 2-1/8 x 7'
 PRIMED



FLUTED CASING
1820 3/8 x 2-1/4 x 7'
 WHITE WOOD, PRIMED



BEADED CASING
1821 3/8 x 2-1/4 x 7'
 WHITE WOOD, PRIMED

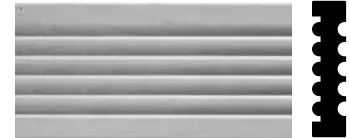

FLUTED/CANED CASING
819D 3/4 x 3 x 7'
 WHITE WOOD

General Purpose Decorative Moulding



COLONIAL MOULDING
589 3/8 x 1-1/4 x 8'
 WHITE WOOD



ROPE EDGE MOULDING
1831 1/2 x 1-3/8 x 8'
 WHITE WOOD



SCALLOP MOULDING
95 7/8 x 1-1/2 x 8'
 WHITE WOOD



IVY MOULDING
425 11/32 x 1-3/4 x 8'
 WHITE WOOD



COLONIAL MOULDING
40 5/16 x 11/16 x 8'
 WHITE WOOD



COLONIAL MOULDING
41 1/4 x 13/32 x 8'
 WHITE WOOD



SAUSAGE & BEAD MOULDING
1160 5/16 x 11/16 x 8'
 WHITE WOOD



ROPE MOULDING
1811 1/2 x 3/4 x 8'
 WHITE WOOD



IVY MOULDING
1425 3/8 x 3/4 x 8'
 WHITE WOOD



OAK LEAF MOULDING
1167 3/8 x 7/8 x 8'
 WHITE WOOD



ROPE MOULDING
2 2002 9/32 x 11/16 x 8'
 WHITE WOOD



DENTIL MOULDING
5022 5/16 x 7/8 x 8'
 WHITE WOOD



PICTURE FRAME
1 0039 27/32 x 3/4 x 8'
 WHITE WOOD



EGG & DART MOULDING
681 9/16 x 1 x 8'
 WHITE WOOD



ROPE MOULDING
311 7/32 x 1 x 8'
 WHITE WOOD



BLOSSOM MOULDING
419 5/16 x 1-1/4 x 8'
 WHITE WOOD



ROPE MOULDING
2 2027 7/16 x 1-1/16 x 8'
 WHITE WOOD

Poly-Classic Square Non-Tapered Column | Cap & Base



PLAIN SQUARE
7 2214 8" x 8'

REGULAR CAP & BASE SET
7 3330 8"

Poly-Classic Round Tapered Column | Cap & Base



PLAIN ROUND
7 2230 8" x 8'
7 2232 8" x 10'
7 2233 10" x 8'
7 2234 10" x 10'

FLUTED ROUND
7 2231 8" x 8'

REGULAR CAP & BASE SET
7 2260 8"
7 2261 10"

7 1760 INSTALLATION KIT

Porch Posts



ACRYLIC PRIMER
D 3148 A 4" x 8'
D 3158 A 5" x 8'
D 3168 A 6" x 8'

PORCH POST FASTENERS
1 7004 UNVSL 4"
1 7005 UNVSL 5"
1 7006 UNVSL 6"

Primed Round Wood Tapered Column | Cap & Base



PLAIN SMOOTH - PRIMED
P 1088 8" x 8'
0810 8" x 10'
1108 10" x 8'
1110 10" x 10'

FLUTED - PRIMED
F 1088 8" x 8'

REGULAR CAP & BASE SET - PRIMED
7 2262 8"
2510 10"

Moulding Index

PROFILE	PG#
M 15	34
16SL	42
18SL	42
41	45
42C	41
L 45	44
L 46	44
L 47	43
L 48	43
L 49	43
52	43
60	43
75	43
86	43
93	46
100	46
103	46
105	46
106	46
108	46
123	46
126	46
129	46
142	46
163	41
L 163E	38
L 176	37
180	37
205	46
206	46
L 210	37
L 217E	39
L G217	33
218	39
L 233	46
239	46
240	46
254	46
L 254	18, 46
L 266	46
273	42
280	18, 42
281	42
289	42
C R291	44
297	41
300	41
B312	39
B G312	18,19,35
S 312	35
327	33
L 338	34

PROFILE	PG#
350	34
356	33
366	33
376	33
390	41
392	41
397	41
L 412	18, 35
S 412	18, 35
433	38
443	33
H 444	33
445	33
453	18, 33
473	18, 33
505	18, 45
B G512	19, 40
S 512	40
E519	18, 43
C 614	44
B 615	40
618	38
620	38
623	38
W 631	39
631	38
713	38
S 712	40
C 714	45
L 726	38
P 813	39
827	36
856	36
L 887	36
887	36
886	36
916	36
947	36
951	36
L 956W	41
W 956W	41
982	36
L 984	36
L 988	36
988	36
995	46
7 1021	37
1021	37
1201	41
1207	41
1215	42
1217	42

PROFILE	PG#
1219	42
3180	34
L 5180	39
5180	39
5187	40
L 8189	39
8189	39
B2	37
B RB3	33
M RB3	34
RB3	34
SCBA	19, 40
SCCA	18, 35
STBA	19, 40
STCA	18, 35
VICC	34
WP4	42

SHIPLAP & BOARDS
PAGE 28

SHEET GOODS
PAGE 29-31

SOFTWOOD &
HARDWOOD BOARDS
PAGE 32

JAMBS - PAGE 37

TURNCRAFT
COLUMNS AND
PORCH POST ON
PAGE 49

PROFILE	PG#
DECORATIVE MOULDING	
1 0039	48
40	48
41	48
95	48
311	48
419	48
425	48
589	48
B 642	47
681	48
B 740	47
B 742	47
B 743	47
819D	48
B 871	47
B 887	47
B 892	48
B 895	48
B 915	47
1124	48
1160	48
1167	48
B 1200	47
1402 C	47
1403	47
1425	48
1691	47
1811	48
1820	48
1821	48
1825	47
1831	48
1888	47
1889	47
1897	47
1898	47
1899	47
2 2002	48
2 2027	48
5022	48



Mouldings

- Softwood Mouldings
- Hardwood Mouldings
- Decorative Wood Mouldings
- Green Mouldings & Boards (FSC Chain of Custody Certified)

PVC Interior/Exterior

- Interior/Exterior
- Crown, Casing, Quarter Round, Brick Mould, Lattice



Boards

Softwood Boards:

- Ultralite MDF
- Clear Radiata Pine
- Finger Joint Primed - Square and Eased Edged

Hardwood Boards:

- Oak Veneer
- Oak
- Poplar



Stair Parts

- Wood Balusters and Newels
- Iron Balusters and Newels
- Post to Post Components
- Over the Post Components
- Stock, Special Order, Custom

Cable Systems/ Panel Systems

- Horizontal infills including cable, tube and panels
- Options for Open Tread, Kneewall & Level Run



Jambs and Frames

- Interior and Exterior
- Primed FJ Pine Interior Flat and Split Jambs
- Primed FJ Pine Exterior Frames (Srks)
- Primed Composite Exterior Frames



Doors

- Shaker, French, Louvered
- Factory Sealed Tops/Bottoms
- Superior Panel Thickness
- Pre-Primed Components
- Superior Construction, More Dowels Per Rail Than Industry Standard
- Fire Doors Available



Columns

- Architectural Wood Columns
- Wood Colonial Columns
- Poly-Classic, Square or Craftsman, Columns
- Poly-Classic Porch Posts
- Wood Porch Posts



ORNAMENTAL

— DECORATIVE MILLWORK —



Custom Run & Decorative Millwork

- Quality Custom and Short Run Moulding Orders
- Quick Turn Around
- Decorative Wood Mouldings
- Mantels, Wood Beams
- Decorative Risers
- Stained Boards



NOVO SHEET GOODS PROGRAM

- Premium Sheets For Hundreds Of Interior Applications
- Over 30 Sku Offerings
- Delivered On Your Next Truck Along With Your Moulding And Millwork





Explore our comprehensive collections of mouldings, stair parts, boards, and exterior millwork as well as find inspiration for every room in the home.



Lakeland Distribution Center

Suite 120
7270 Bridgewater Center Drive
Lakeland, FL 33805

P: 800.253.9000 | F: 863.683.3415

© 2023 NOVOBP, Lakeland (Rev. 11/23)

NOVO reserves the right to make changes to the products listed in this catalog without notice and without responsibility for existing units. Drawings may not be to exact scale.

For more information
scan to visit
NOVOBP.COM

