

IMPORTANT: Please read instructions thoroughly before beginning installation.

The following instructions are designed to be used for the installation of our Linear Collection metal newels and cable railing. The rake newels in this collection are designed for stairways with 7 1/2" rise and 10" run (approx 36.8°), a rake handrail height of 34"-37" and a level handrail height of 36", 39" or 42". We recommend installing a newel at every corner or change in direction making each straight run separate cable with a fixed cable fitting on one end and a tensioner cable fitting on the other end into the newel posts. Tensioner cable fittings should be used on both ends of any cable run that is 25' to 50' long. Before proceeding with the following steps, the balustrade centerline should be marked on the treads and balcony. **Consult your local building code official before purchasing and installing this system.** Cable railing is intended to be used as a guard/fence and is not meant or designed to be stood on or climbed upon or installed in any condition involving motion. Load limits and breaking points may vary depending on installation. An engineer or qualified contractor should be consulted regarding the suitability of this system for particular applications.

Linear Metal Newel Applications

Open Tread Rake Up Newel (CR-310U)	Use this newel as the starting newel on the first tread at the bottom of an open tread stairway flight.
Open Tread Rake Pass Through Newel (CR-320)	Use this newel on open tread stairs at 42" intervals between the newels at the bottom and top of each flight.
Open Tread Rake Down Newel (CR-310D)	Use this newel at the top of the first flight of any L-shaped open tread stairway. Also used at the top of any flight that ends at a wall.
Kneewall Rake Up Newel (CR-KW310U)	Use this newel as the starting newel on the first tread at the bottom of a kneewall stairway flight.
Kneewall Rake Pass Through Newel (CR-KW320)	Use this newel on kneewall stairs at 42" intervals between the newels at the bottom and top of each flight.
Kneewall Rake Down Newel (CR-KW310D)	Use this newel at the top of any kneewall stairway flight.
Level Start/Stop Newel (CL-310)	Use this newel at the beginning or end of each level run. Also used on the level run that transitions from a kneewall stair flight.
Level Pass Through Newel (CL-320)	Use this newel on level runs midway between the Level Start/Stop, Level Corner and Level Down Newels at 42" intervals.
Level Corner Newel (CL-310C)	Use this newel at the corner of two level runs.
Level Down to Level Straight Newel (CL-310DS)	Use this newel on the second floor landing at the top of the stairway flight that transitions to a straight level run.
Level Down to Level Left Newel (CL-310DL)	Use this newel on the second floor landing at the top of the stairway flight that transitions left to a level run.
Level Down to Level Right Newel (CL-310DR)	Use this newel on the second floor landing at the top of the stairway flight that transitions right to a level run.

Tools/Materials list:

Power Drill	1/2" Box End Wrench	Optional Item:
1/8" Cable Cutter	#2 Phillips Drill Tip or Phillips	6"-8" piece of PVC tube
Two 3/8" Open End Wrenches	Screwdriver	
3/16" Allen Wrench	Tape Measure	
5/32" Allen Wrench	Cable Release Tool	
1/8" Twist Bit	Safety Glasses	
1/4" Twist Bit		

Place and Mount the Rake Newels:

Refer to the above table for placement of newels. Each newel post comes with four mounting lag bolts.

1. Mark the placement of the Newels on the rake centerline. The front edge of the bottom plate on the Rake Up Newel must be exactly 2 1/4" from the front edge of the bottom tread (A). The front edge of the bottom plate on the Level Down Newel at the landing must be exactly 2 1/4" from the front edge of the landing tread (B).

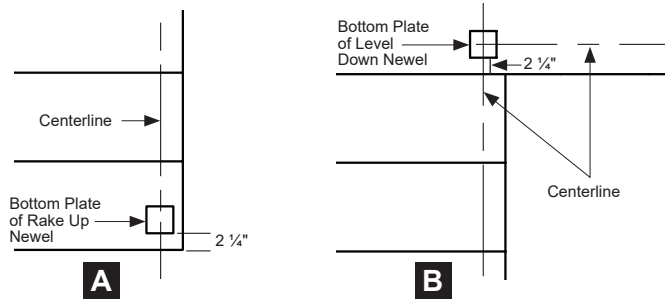

2. We recommend installing at least the top and bottom rake cable fittings into the Rake Up Newel & Level Down Newel to avoid obstructions while using the articulating portion of the fitting as a lever to rotate the machine threads into the newel face (C). See Installing **Rake Cable Rail Fittings** section of these instructions.

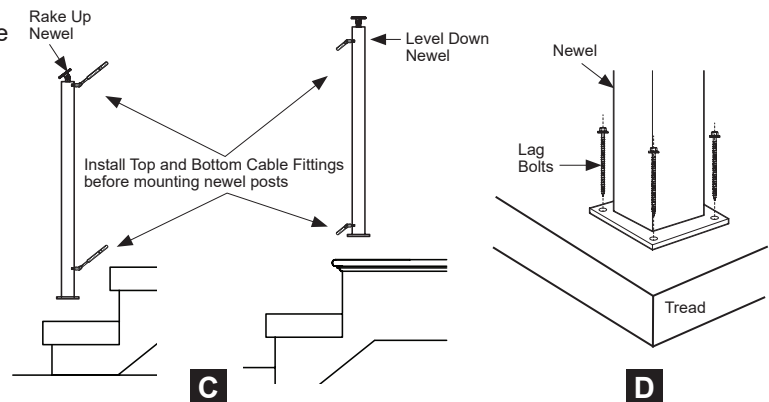

3. Using the plate on the bottom of each newel as a template, mark and predrill 1/4" holes for the provided 2 1/2" lag bolts. Mount each newel using all four lag bolts and a 1/2" box end wrench (D).

4. The distance between the Rake Up Newel and Level Down Newel should not exceed 42". If the distance is greater than 42", a Rake Pass Through Newel must be installed at 42" maximum intervals between the mounted newels (E). Mount each Rake Pass Through Newel on the centerline making sure the front edge of the bottom plate of the newel is exactly 2 1/4" from the front edge of the tread.

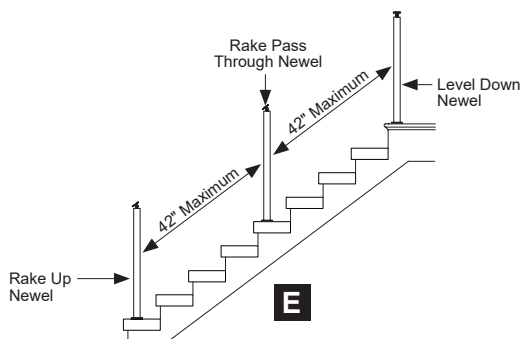

Place and Mount the Level Run Newels:

Refer to the table on page 1 for placement of newels. Each newel post comes with four mounting lag bolts.

- Using the plate on the bottom of each newel as a template, mark and predrill 1/4" holes for the provided 2 1/2" lag bolts. Using all provided 2 1/2" lag bolts and a 1/2" box end wrench, mount the Level Start/Stop Newel on the level run centerline at the end of the level run (F). Mount a Level Corner Newel at each level run corner in the same manner.

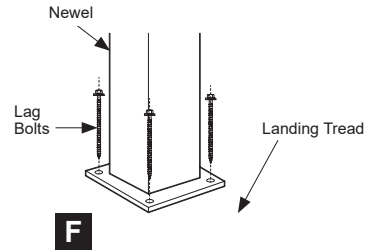

- The distance between the newels should not exceed 42". If the distance is greater than 42", a Level Pass Through Newel must be installed at 42" maximum intervals between the installed Level Newels. Mount each Level Pass Through Newel on the centerline (G).

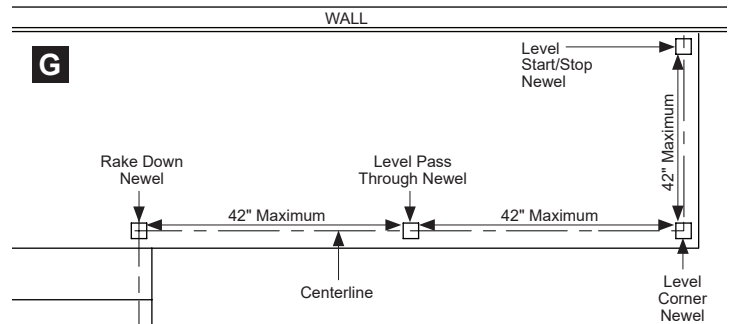

Install the Handrail onto the Newels:

- Trim the 684 handrail to length for each run. Utilize handrail fittings for making turns or changes in elevation (if desired).
- Set the handrail in position on top of the newel brackets. Using the brackets as templates, mark the locations for the wood screws on the under side of the handrail (H).
- Unassemble the top bracket from each newel by removing the flat head machine screw using a 5/32" Allen wrench (I).
- Using a 1/8" twist bit, predrill a 1" deep hole at each marked location on the bottom side of the handrail to accept the newel bracket screws. Fasten the brackets to the handrail using the provided wood screws being careful to orient each bracket correctly (J).
- Position the handrail in place aligning the attached brackets to each respective newel. Reinstall the flat head machine screws to secure the brackets with attached handrail to the newels (K).

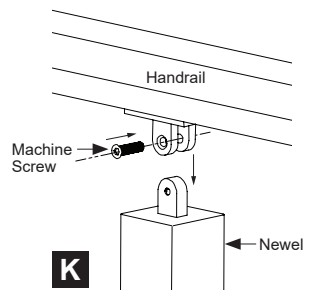
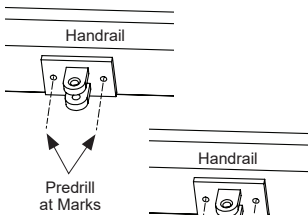
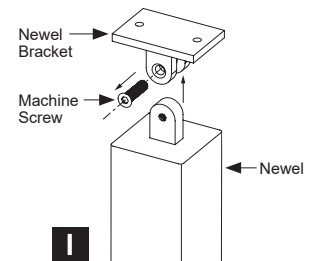
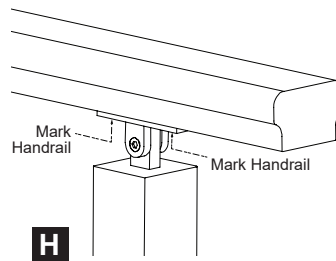

Install 1" Wood Screws

Install the Rake Cable Rail Fittings:

If cable rail fittings will be installed directly into a wall, be sure there are double 2x4s behind the finished drywall and cable fittings designed for installation into wood must be used (CR-WDFGS-SS)

- Install the Fixed Rake Fittings into the Level Down Newel by driving the machine threads into each hole. Use the articulating portion of the fitting as a lever to rotate the machine threads end of the fitting into the newel (L). *Tip: Using a 6"-8" piece of 3/4" PVC tube over the articulating portion may make this task easier.*

Stop turning when the fitting shoulder makes contact with the newel face. Continue to rotate the fitting up to 1/4 turn to properly orient the fitting or it may be backed off 1/4 turn to achieve the proper orientation. **DO NOT OVERTIGHTEN AS THIS MAY RESULT IN STRIPPING THE HOLE.**

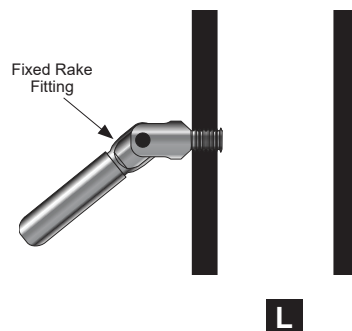

- To install the Tensioner Rake Fittings, drive the machine threads of the hinged portion of the fitting into the hole on the Rake Up Newel. Using the articulating portion of the fitting as a lever to rotate the threads of the fitting into the newel (**M**). *Tip: Using a 6"-8" piece of 3/4" PVC tube over the articulating portion may make this task easier.*

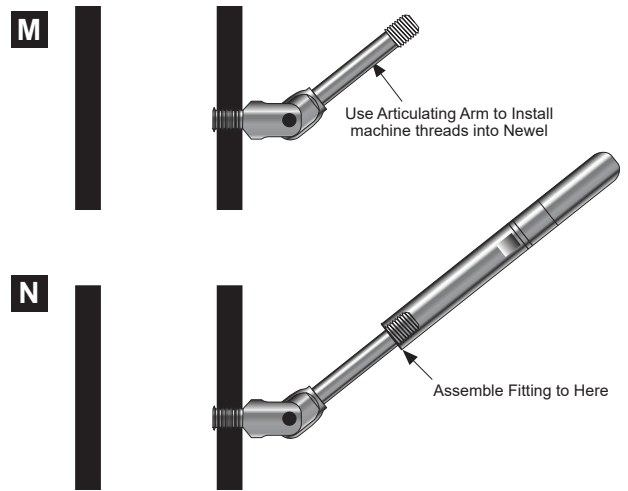

Stop turning when the fitting shoulder makes contact with the newel face. You may continue to rotate the fitting up to 1/4 turn to properly orient the fitting or it may be backed off 1/4 turn to achieve the proper orientation. **DO NOT OVERTIGHTEN AS THIS MAY RESULT IN STRIPPING THE HOLE.**

- Assemble the female threaded rotating portion of the fitting onto the male thread only so far as to cover the male threads and no more. (**N**)

Install the Level Cable Rail Fittings:

If cable rail fittings will be installed directly into a wall, be sure there are double 2x4s behind the finished drywall and cable fittings designed for installation into wood must be used (CL-WDFTGS-SS)

- Install the Fixed Level Fittings into the Level Newel at one end of the level run by driving the machine threads into each hole using a 3/8" open-end wrench on the wrench flats milled into the body of the fitting (**O**).

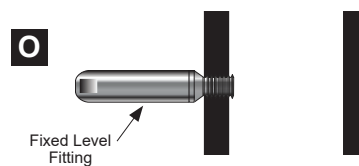

Stop turning when the shoulder makes contact with the newel face. **DO NOT OVERTIGHTEN AS THIS MAY RESULT IN STRIPPING THE HOLE.**

- To install the Tensioner Level Fittings, drive the machine threads of the male portion of the fitting into the hole on the Level Newel at the opposite end of the level run by using a 3/16" hex (Allen) wrench (**P**).

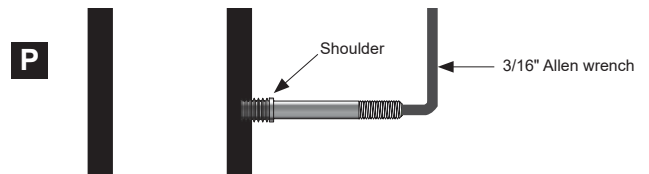

Stop turning when the shoulder makes contact with the newel face. **DO NOT OVERTIGHTEN AS THIS MAY RESULT IN STRIPPING THE HOLE.**

- Assemble the female threaded rotating portion of the fitting onto the male thread only so far as to cover the male threads and no more. (**Q**)

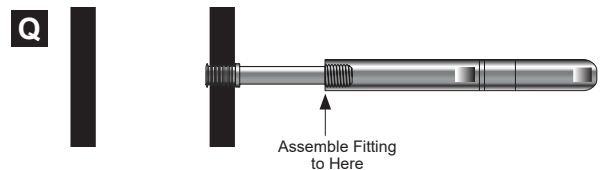

Install the Cable:

IMPORTANT: All cable cut ends must be "clean" and burr free. We recommend using a cable cutter that encircles the cable as it cuts it. When inserting a cut end of the cable into our cable fittings it is important to rotate the cable and/or fitting in a direction that is "with the lay" of the cable strand. For Left Hand lay strand, rotate the cable and the fitting clockwise. This will help to prevent the cable from fraying or "unlaying" while it is inserted into the fitting. Insert cut cable end into the cable fitting approximately 1.062" until you feel it rest against a hard stop and then pull against the fitting to secure the wedges in the fitting. If the cable lay is not smooth upon full insertion into the fitting, the Cable Release Tool (C-RELEASE) can be used to release the cable from the fitting so a second attempt can be made to insert the cable end into the fitting.

Steps 1-3 should be performed one cable at a time before proceeding to step 4.

- Begin by inserting the cut end of the cable into the Fixed (non-tensioning) Fitting as described to the right (**R**). **FULL INSERTION OF THE CABLE IS CRITICAL TO FITTING PERFORMANCE UNDER TENSION.**

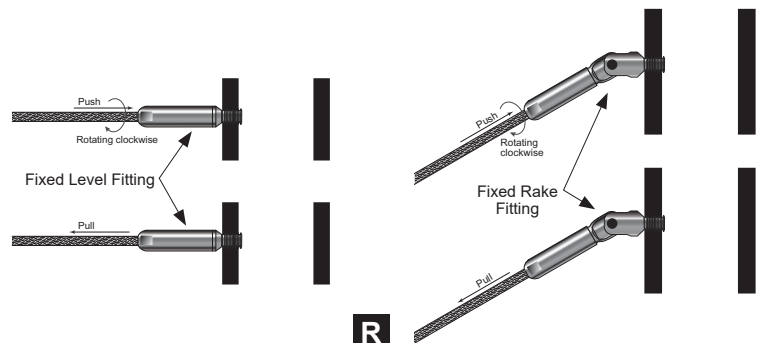

2. Feed the cable through any Pass Through Newels toward the Tensioner Fitting at the opposite end of the run. Mark the cable at the score mark on the body of the fitting. Cut the cable at this mark (S).

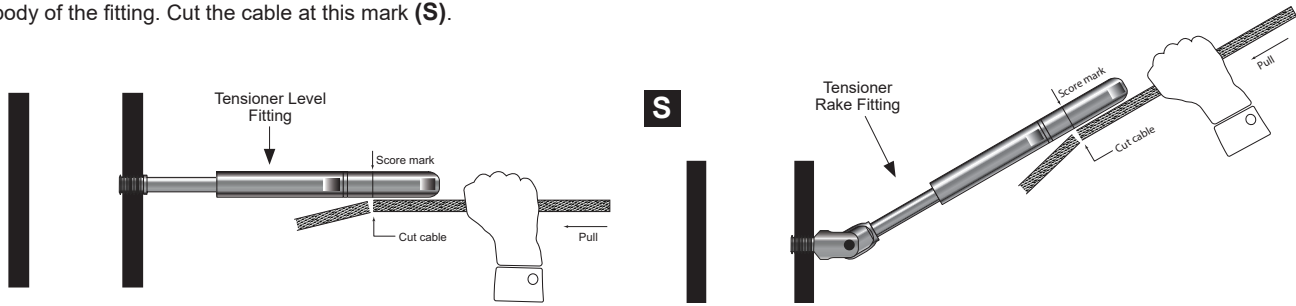

3. Loosen the Tensioner Fitting so that approximately 5 or 6 threads are showing and insert the cable end into the fitting as described in the preface of this section (T). **FULL INSERTION OF THE CABLE IS CRITICAL TO FITTING PERFORMANCE UNDER TENSION.**

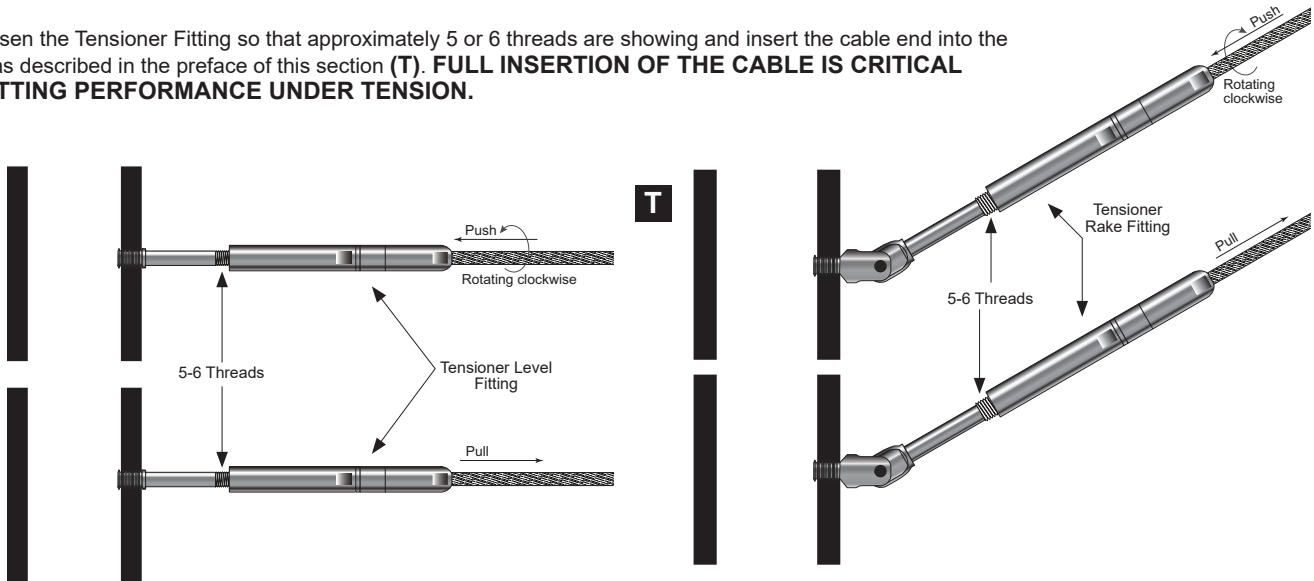

4. Following the Tensioning Sequence to the right, tension each cable by holding the tensioner fitting body with a 3/8" open end wrench on the wrench flat nearest the cable (Do not let this section rotate while cable is inserted). Using a second 3/8" open end wrench, rotate the female threaded section of the fitting onto the male threads (U). Consult local building codes for the desired tension on cables. Start tensioning at the top and bottom cables of the run and work in an alternating pattern toward the center of the run as shown in the illustration to the right. It may be necessary to make two passes at this process because the frame may flex as the cables are initially tensioned, thus allowing the previously tensioned cables to slightly lose tension.

TENSIONING SEQUENCE

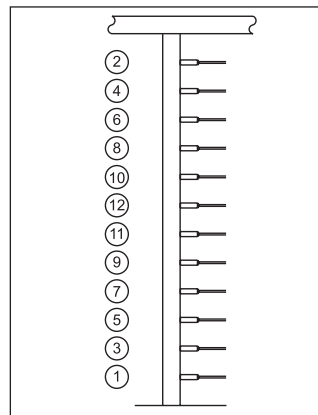

The tension on the cables will need periodic adjustment by using two 3/8" open end wrenches as described in step 4 above.

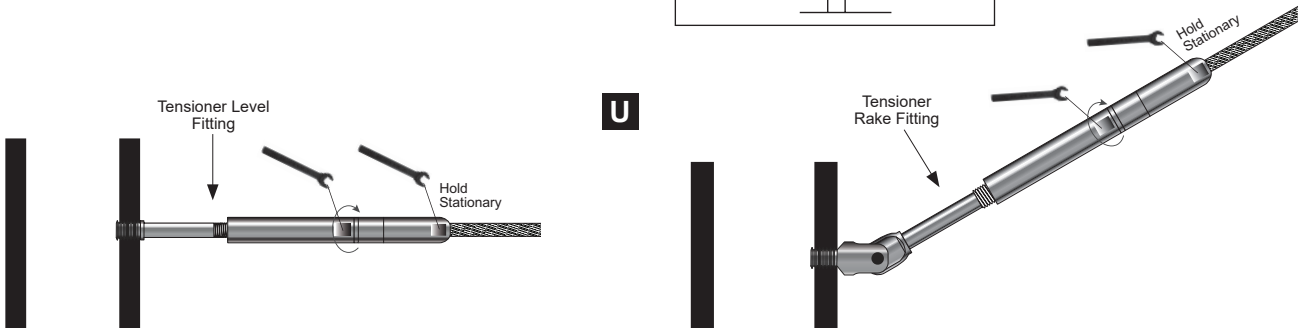

35280 Scio-Bowerston Road • Bowerston, OH 44695
740-269-2221 • (Fax) 740-269-9047
www.LJSmith.com